

This publication was developed by Southface Institute in partnership with the Georgia Environmental Finance Authority (GEFA). It is intended to serve as a tool and support document for understanding the Georgia Energy Code but does not replace or supercede the official Georgia State Supplement and Amendments, which can be accessed at www.dca.ga.gov/node/5689.

This publication is free to download, print, and distribute. This publication may not be sold or repurposed for any commercial purposes (e.g., as a resource in paid trainings or inclusion in a for-sale publication) without express written consent from Southface Institute.

Georgia Residential Energy Code FIELD GUIDE

2015 IECC® + 2020 Georgia
State Supplements & Amendments

How to Use the Field Guide

This guide is intended to help explain the residential portion of the 2020 Georgia Energy Code and does not necessarily include all aspects and details. It is intended to serve as a tool and support document for understanding the Georgia Energy Code but does not replace or supercede the official Georgia State Supplement and Amendments, which can be accessed at www.dca.ga.gov/node/5689.

This guide is organized by building component and attempts to compile all relevant information and key practices related to each component. Each entry includes references to all relevant sections of 2015 IECC and/or 2020 Georgia amendments, along with occasional references to the International Residential Code (IRC). Where applicable, each entry also provides summary details of requirements (such as R-values or U-factors) for each Georgia climate zone.

Need Help?

Additional Online Resources:

www.southface.org/education/our-courses/georgia-energy-code-support-documents

Southface Institute Energy Code Helpline:

energycodes@southface.org

404-604-3598

Credits

Principal authors:

Mike Barcik, Southface Senior Technical Principal

Paul Bazen, Southface Technical Project Manager

Graphic design and illustration:

Greg Brough, Southface Senior Technical Principal

Editor: Mike L. Ford, Southface Project Manager

CONTENTS

Introduction	1
Insulation R-Values.....	10
Passing Grade Details.....	11
Slab Edge Insulation.....	13
Basement Wall Insulation.....	14
Crawl Space Wall Insulation.....	17
Crawl Space Vapor Retarder.....	18
Floor Insulation.....	19
Wall Insulation.....	21
Mass Wall Exterior and Interior Insulation.....	24
Ceiling Insulation.....	25
Wind Wash Baffle and Air-Permeable Insulation Dam.....	28
Access Hatches and Doors.....	30
Attic Kneewalls.....	32
Fenestration U-Factor.....	35
Skylight U-Factor.....	36
Solar Heat Gain Coefficient (SHGC) Values for Glazed Fenestration and Skylights.....	37
Fenestration Air Leakage.....	38
IC-Rated Recessed Lighting Fixtures (Sealing).....	39
Air-Seal and Insulate Tubs and Showers.....	40
Air-Seal Window/Door Openings.....	42
Air-Seal Assemblies Separating Garage.....	43
Air-Seal Bottom and Top Plates.....	44
Air-Seal Seams in Exterior Air Barrier.....	46
Air-Seal Utility Penetrations.....	47
Air-Seal Dropped Soffit Ceilings and Chases.....	48
Air-Seal Rim/Band Joist Junctions.....	50
HVAC Piping Insulation.....	51
Hot Water Pipe Insulation.....	52
Service Hot Water Systems.....	53
Duct Insulation.....	54
Duct Sealing.....	55
Building Cavities May Not Be Used as Ducts or Plenums.....	57
Heating, Cooling, and Water-Heating Equipment.....	58
Primary Heat Source.....	59
Programmable Thermostat.....	59
Heat Pump Controls.....	60
Rooms Containing Combustion Appliances.....	61
Mechanical Ventilation.....	63
Power Attic Ventilators.....	65
Outdoor Intake/Exhaust Openings.....	65
Duct Tightness Testing.....	66
Blower Door Testing.....	67
Energy Code Compliance Certificate.....	69
Lighting.....	70
Wood-Burning Fireplaces.....	71
Heated Swimming Pools and Spas.....	72

INTRODUCTION

Why the Energy Code Matters

The 2020 Georgia Energy Code represents the code's first major revision in nearly a decade. It is based on the 2015 International Energy Conservation Code® (IECC) and the 2020 Georgia State Supplements and Amendments.

This upgraded code is important for all Georgians. For those living in single-family buildings or low-rise multifamily residential buildings, the energy code helps ensure cost-efficient homes while also improving comfort and durability. For builders, it creates a level playing field while decreasing liability. For the environment, it reduces carbon and other emissions thanks to reduced energy production and usage.

Impacts on the Energy Code

In 2015, Georgia participated in a Department of Energy sponsored Energy Code Field study to assess compliance with the 2011 Georgia Energy Code (2009 IECC + 2011 GA Amendments). The study focused on eight key areas: foundation, wall, and ceiling insulation; window U-factor and Solar Heat Gain Coefficient (SHGC); house air leakage; duct sealing; and efficient lighting.

The results were generally encouraging with the following areas identified as opportunities for improvement:

- Insulation R-values generally met code, but the quality of the insulation installation was substandard.
- Houses were reasonably tight, averaging 4.9 ACH₅₀ and almost always < 7 ACH₅₀.
- Duct systems were moderately leaky, with the leakiest systems being inside the thermal envelope.
- Compliance with efficient lighting for 50% of the bulbs was poor; only 1 in 3 homes complied.

If new houses are built to correct these deficiencies, these new Georgia homeowners will save over \$3.1 million annually in utility costs. Based on these findings and opportunities—and the call to upgrade Georgia's energy code—the 2015 IECC was reviewed and amended with a January 1, 2020 date for implementation and enforcement.

Changes and Highlights

Georgia's 2020 Energy Code brings forward most existing amendments and introduces a few new ones.

Overall, the amended code brings minimal changes to the building thermal envelope components:

- Ceiling insulation increases from R-30 to R-38 in Climate Zones (CZ) 2 and CZ3 but remains R-38 (instead of R-49) in CZ4.
- Windows get better (in theory) but effectively remain the same double-paned low-e windows commonly installed today (max U-factor 0.35, max SHGC 0.27).

- House leakage changes to < 5 ACH₅₀ (an improvement from the current < 7 ACH₅₀), which is not as stringent as the < 3 ACH₅₀ IECC target.
- For ducted mechanical systems, allowable duct leakage reduces from 12% leakage to 6% for "final" or post-construction (final) total leakage (PCT), but it remains at 6% for rough-in total leakage (RIT).
- Duct post-construction leakage-to-outside (PCO) is no longer recognized as a testing option.
- New home heat pump systems require supplemental electric strip heat lockout until the outdoor temperature is below 40°F.
- Clarification was created for variable capacity HVAC units in terms of equipment sizing and selection as per Air-Conditioning Contractors of America (ACCA) Manuals J and S.

Residential one- and two-family dwellings testing < 3 ACH₅₀ air tightness now require a whole-house mechanical ventilation system as per the 2020 Georgia State Supplements and Amendments to the 2018-IRC. Ventilation strategies range from simple exhaust-only and sensor-based supply-only to ventilating dehumidifiers and balanced ERVs (energy recovery ventilators). The IRC provides a table specifying the minimum ventilation to be provided.

For hot water lines, R-3 pipe insulation is prescriptively required for all hot water plumbing outside the thermal envelope and for any lines 3/4" and greater. Unless a simulation-based trade-off is used, hot water lines must meet the insulation requirements of section R403.5.3. Hot water recirculating systems must be pumped and require insulated lines if controlled by a timer. Demand control recirculation systems are otherwise exempt from pipe insulation.

Compliance Pathways

The IECC focuses heavily on the building thermal envelope (the air barrier plus insulation barrier that together contain the conditioned space). In addition, there are a few requirements pertaining to other systems such as ductwork and mechanical systems, as well as hot water piping. Items in the code are either mandatory (meaning they must be done and there is no trade-off) or prescriptive (meaning they represent the baseline, but could potentially be traded off). To comply with either the insulation R-value or the assembly U-factor for each building component, the builder should consult the prescriptive tables, available in 2015 IECC Chapter 4.

Compliance with the envelope requirements of the code is generally met using the prescriptive pathway. Under this approach, meeting (or exceeding) the "recipe" for each building component is the most straightforward means to demonstrating compliance. If the permit applicant satisfies the prescriptive code and meets all the mandatory requirements, energy code compliance is achieved.

When a house design varies from the prescriptive code, a trade-off must be employed. Trade-offs range from the fairly simple UA analysis spreadsheet and software programs like RESCheck to the more complex, computer-based analyses such as the Simulated Performance Alternative and the brand new Energy Rating Index (ERI) option.

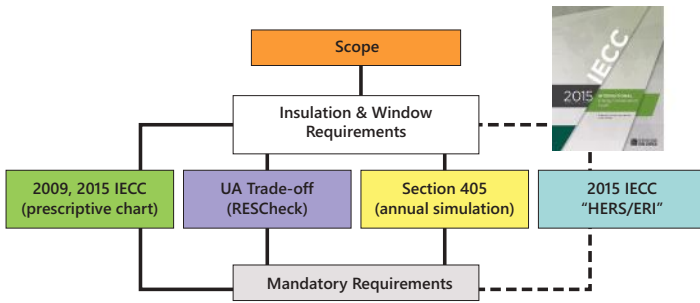

Compliance Pathways and Trade-Offs

Comparing 2015 IECC and 2020 Georgia Amendments

As seen in the tables below, Georgia did not adopt the 2015 prescriptive code as written. The red outlined boxes indicate items that would have changed from the 2011 code. The second table shows the prescriptive Georgia energy code with the values in red indicating items that were altered from the 2011 prescriptive code.

For example, the prescriptive 2015 energy code requires R-20 walls for climate zones 3 and 4, but this was amended to keep them at R-13. Likewise, ceiling insulation increased to R-38 for CZs 2-3 but was not increased to R-49 for CZ4.

The actual prescriptive R-value (and U-factor) tables are found in the 2020 Georgia State Supplements and Amendments:

2015 Prescriptive R-values												
Climate Zone	Fenestration U-factor	Skylight U-factor	Glazing SHGC	Ceiling	Wood Walls	Attic Kneewall	Mass wall	Floor	Basement Wall	Slab	Crawl Wall	ACH50
2	0.40	0.65	0.25	38	13	13	4/6	13	0	0	0	<5
3	0.35	0.55	0.25	38	20 or 3+5	20 or 3+5	8/13	19	5/13	0	5/13	<3
4	0.35	0.55	0.40	49	20 or 3+5	20 or 3+5	8/13	19	10/13	10, 2ft	10/13	<3
Proposed Compromise Prescriptive R-values (Red indicates changes from current GA code)												
Climate Zone	Fenestration U-factor	Skylight U-factor	Glazing SHGC	Ceiling	Wood Walls	Attic Kneewall	Mass Wall	Floor	Basement Wall	Slab	Crawl Wall	ACH50
2	0.35	0.65	0.27	38	13	18	4/6	13	0	0	0	<5
3	0.35	0.55	0.27	38	13	18	8/13	19	5/13	0	5/13	<5
4	0.35	0.55	0.27	38	13	18	8/13	19	10/13	0	10/13	<5

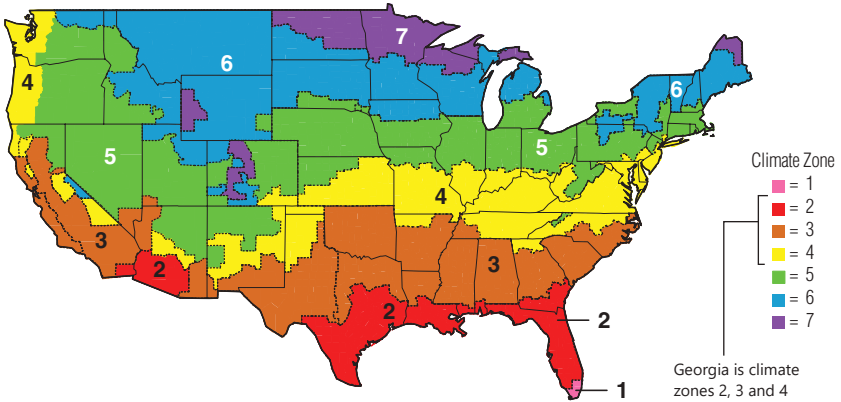

If a trade-off from the prescriptive requirements is used, the mandatory Compliance Alternative Constraints limits must be met. This table is in essence a “can’t trade to zero limit,” which states that while certain components may have lower insulation levels than their prescriptive amount, those values cannot be reduced below a certain threshold.

Table R402.1.2
Insulation and Fenestration Requirements by Component

Climate Zone	Fenestration U-Factor	Skylight U-Factor	Glazed Fenestration SHGC	Ceiling R-Value	Wood Frame Wall R-Value	Attic Knee-wall R-value	Mass Wall R-Value	Floor R-Value	Basement Wall R-Value	Slab R-Value + Depth	Crawl Space Wall R-Value
2	0.35	0.65	0.27	38	13	18	4/6	13	0	0	0
3	0.35	0.55	0.27	38	13	18	8/13	19	5/13	0	5/13
4 except marine	0.35	0.55	0.27	38	13	18	8/13	19	5/13	0	10/13

Table R402.1.4
Equivalent U-Factors

Climate Zone	Fenestration U-Factor	Skylight U-Factor	Ceiling U-Factor	Frame Wall U-Factor	Mass Wall U-Factor	Floor U-Factor	Basement Wall U-Factor	Crawl Space U-Factor
2	0.35	0.65	0.030	0.084	0.165	0.064	0.360	0.477
3	0.35	0.55	0.030	0.084	0.098	0.047	0.091	0.136
4	0.35	0.55	0.030	0.084	0.098	0.047	0.059	0.065

For example, the prescriptive ceiling R-value requirement is R-38, but a sprayed foam roofline (vaulted unvented attic roofline air-impermeable) could (with a valid trade-off) be reduced to less than R-38; however, it cannot be installed at less than R-20. It is up to the permit applicant to document and demonstrate to the code official that a valid trade-off has been performed.

R402.1.6 Compliance Alternative Constraints. (Mandatory)

Where Compliance Alternative Pathways are used, the minimum R-values, maximum U-factors, and maximum SHGCs for thermal envelope components in projects complying under this code (including the use of REScheck) shall be according to Table 402.1.6. Compliance Alternative Pathways include Total UA Alternative, Simulated Performance Alternative, and Energy Rating Index Alternative.

Table R402.1.6
Minimum Insulation R-Values for Envelope Components When Trade-Offs Are Used

Climate Zone	Wood ^d Framed Walls	Mass ^{a,b} Wall	Attic ^{c,e} Kneewall	Basement ^a Wall	Crawl ^b Wall	Floor Over Unheated Spaces	Ceilings with Attic Space	Vaulted ^{c,d} Unvented Attic Roofline Air-impermeable	Vaulted ^{c,d} Unvented Attic Roofline Air-permeable	Cathedralized ^{c,d} Vented Ceiling Roofline Air-permeable
2	13	4	18	0	0	13	30	20	20+5*	20
3	13	5	18	5	5	13	30	20	20+5*	20
4	13	5	18	5	5	13	30	20	20+15*	20

a: Weather-stripped hinged vertical doors (minimum R-5 insulation or maximum U-0.20), weather-stripped hatches/scuttle hole covers (minimum R-19 insulation or maximum U-0.05), or weather-stripped and disappearing/pull-down stairs (minimum R-5 insulation or maximum U-0.20) shall be deemed to meet the minimum insulation R-values of the corresponding envelope element.

b: Any mass wall (masonry, CMU, etc.)

c: Attic kneewall for the purpose of this code is defined as any vertical or near-vertical wall in the building envelope that has conditioned space on one side and attic space on the other side.

Exception: When the building roofline is insulated, the former kneewall is classified as an interior wall.

d: Examples of air-impermeable insulation include spray foam and rigid foam board. Examples of air-permeable insulation include fiberglass batts and cellulose. See 'Roofline Installed Insulation Options' in Appendix RA of the Georgia State Supplements and Amendments for details.

Trade-Off Approaches

Following is a summary of the various trade-off approaches. Important: no matter which trade-off compliance option is used, the “can’t trade to zero” requirements of section 402.1.6 must be satisfied.

UA Trade-Off (Spreadsheet): This method involves a simple spreadsheet approach to demonstrate that the sum total UA for the proposed home is equal to or lower than the identical code home built to comply with Table 402.1.4.

RESCheck: This free UA trade-off software tool from www.energycodes.gov may be used as long as the user selects 2015 IECC as the baseline code. The challenge in using this tool is that RESCheck is based on the actual 2015 code and not the amended GA Table 402.1.4.

Simulated Performance Alternative: This annual computer simulation allows for trade-offs within the thermal envelope. This approach is more complex and usually requires a knowledgeable user with access to the software, such as a Home Energy Rating System (HERS) rater. If the proposed house design can be simulated and shown to be equal to or lower in annual energy cost when compared to a simulation of the same house built exactly to prescriptive code, the proposed design complies.

Energy Rating Index (ERI): Similar to a HERS rating, this compliance approach looks at all the energy used in the home, which means items like higher efficiency HVAC, water heating; even appliances like refrigerators and dishwashers are accounted for. The computer analyzes all energy used for heating, cooling, water heating, lights, appliances, and renewable energy systems in the proposed house and compares the energy usage to that of a home built to a baseline 2006 IECC level. This ratio creates an index wherein a lower number is more efficient and each index point represents a 1% difference compared to the reference home.

For example, an index of 100 means the home just meets the 2006 IECC reference home, while a home built to the 2009 IECC would likely be in the low-to-mid 80s (approximately 15–20% more efficient than the reference home). For GA 2020 energy code compliance, threshold index targets of **57** must be met for the proposed house in CZs 2-3, while the limit for CZ4 is **62**.

Appendix RA: Air Sealing and Insulation Key Points

Compliance with mandatory air sealing and insulation is done through Appendix RA – page 1.

Appendix RA

Air Sealing and Insulation Key Points

	COMPONENT	AIR BARRIER CRITERIA	INSULATION INSTALLATION CRITERIA
1	General requirements	A continuous air barrier shall be installed in the building envelope. The exterior thermal envelope contains a continuous air barrier. Breaks or joints in the air barrier shall be sealed.	Air-permeable insulation shall not be used as a sealing material.
2	Ceiling/attic	The air barrier in any dropped ceiling/soffit shall be aligned with the insulation and any gaps in the air barrier shall be sealed. Access openings, drop down stairs or knee wall doors to unconditioned attic spaces shall be sealed.	The insulation in any dropped ceiling/soffit shall be aligned with the air barrier.
3	Walls	The junction of the foundation and sill plate shall be sealed. The junction of the top plate and the top of exterior walls shall be sealed. Knee walls shall be sealed.	Cavities within corners and headers of frame walls shall be insulated by completely filling the cavity with a material having a thermal resistance of R-3 per inch minimum. Exterior thermal envelope insulation for framed walls shall be installed in substantial contact and continuous alignment with the air barrier.
4	Windows, skylights and doors	The space between window/door jams and framing, and skylights and framing shall be sealed.	
5	Rim joists	Rim joists shall include the air barrier.	Rim joists shall be insulated.
6	Floors (including above garage and cantilevered floors)	The air barrier shall be installed at any exposed edge of insulation.	Floor framing cavity insulation shall be installed to maintain permanent contact with the underside of subfloor decking, or floor framing cavity insulation shall be permitted to be in contact with the top side of sheathing, or continuous insulation installed on the underside of floor framing and extends from the bottom to the top of all perimeter floor framing members.
7	Crawl space walls	Exposed earth in unvented crawl spaces shall be covered with a Class I vapor retarder with overlapping joints taped.	Where provided instead of floor insulation (unvented crawl spaces), insulation shall be permanently attached to the crawlspace walls.
8	Shafts, penetrations	Duct shafts, utility penetrations, and flue shafts opening to exterior or unconditioned space shall be sealed.	Capped chases shall be insulated to surrounding ceiling R-values (maintain clearance from combustion flues).
9	Narrow cavities		Batts in narrow cavities shall be cut to fit, or narrow cavities shall be filled by insulation that on installation readily conforms to the available cavity space.
10	Garage separation	Air sealing shall be provided between the garage and conditioned spaces.	Band area shall be blocked, sealed and insulated.
11	Recessed lighting	Recessed light fixtures installed in the building thermal envelope shall be sealed to the drywall.	Recessed light fixtures installed in the building thermal envelope shall be air tight and IC rated.
12	Plumbing and wiring	Wiring and plumbing penetrations shall be sealed.	Batt insulation shall be cut neatly to fit around wiring and plumbing in exterior walls, or insulation that on installation readily conforms to available space shall extend behind piping and wiring.
13	Shower/tub on exterior wall	The air barrier installed at exterior walls adjacent to showers and tubs shall separate them from the showers and tubs.	Exterior walls adjacent to showers and tubs shall be insulated.
14	Electrical/phone box on exterior walls	The air barrier shall be installed behind electrical or communication boxes or air-sealed boxes shall be installed.	
15	HVAC register boots	HVAC register boots shall be sealed to the subfloor or drywall.	Boots in unconditioned spaces shall be insulated. Recommend insulating boots in conditioned spaces for condensation control.
16	Concealed sprinklers	When required to be sealed, concealed fire sprinklers shall only be sealed in a manner that is recommended by the manufacturer. Caulking or other adhesive sealants shall not be used to fill voids between fire sprinkler cover plates and walls or ceilings.	
17	Blocking between framing (e.g. beneath knee walls, cantilevered floors, garage separation walls)	Blocking shall be sealed to framing.	Insulation shall be in contact with blocking.
18	Common walls	Air barrier is installed in common wall between dwelling units.	
19	Fireplaces	New wood-burning fireplaces shall have tight-fitting flue dampers or doors, and outdoor combustion air.	Fireplace chase insulation shall be restrained to stay in place.

Disclaimer: This document was created by Southface and is intended solely to help graphically demonstrate the air leakage and insulation provisions of the 2015 IECC (2020 Georgia Energy Code). It does not cover all air sealing locations, materials or techniques. Other code provisions may be applicable as well.

Georgia International Energy Conservation Code Supplements and Amendments 2020

In Appendix RA, the pages following the above table are illustrative of methods of demonstrating compliance, including sealing duct systems with mastic, many of which are shown in this field guide. The disclaimer throughout the document is important; not all methods of framing, air sealing, and insulating are shown.

2A Appling*	2A Atkinson*	2A Bacon*	2A Baker*
3A Baldwin	4A Banks	3A Barrow	3A Bartow
3A Ben Hill*	2A Berrien*	3A Bibb	3A Bleckley*
2A Brantley*	2A Brooks*	2A Bryan*	3A Bulloch*
3A Burke	3A Butts	3A Calhoun*	2A Camden*
3A Candler*	3A Carroll	4A Catoosa	2A Charlton*
2A Chatham*	3A Chattahoochee*	4A Chattooga	3A Cherokee
3A Clarke	3A Clay*	3A Clayton	2A Clinch*
3A Cobb	3A Coffee*	2A Colquitt*	3A Columbia
2A Cook*	3A Coweta	3A Crawford	3A Crisp*
4A Dade	4A Dawson	2A Decatur*	3A DeKalb
3A Dodge*	3A Dooly*	3A Dougherty*	3A Douglas
3A Early*	2A Echols*	2A Effingham*	3A Elbert
3A Emanuel*	2A Evans*	4A Fannin	3A Fayette
4A Floyd	3A Forsyth	4A Franklin	3A Fulton
4A Gilmer	3A Glascock	2A Glynn*	4A Gordon
2A Grady*	3A Greene	3A Gwinnett	4A Habersham
4A Hall	3A Hancock	3A Haralson	3A Harris
3A Hart	3A Heard	3A Henry	3A Houston*
3A Irwin*	3A Jackson	3A Jasper	2A Jeff Davis*
3A Jefferson	3A Jenkins*	3A Johnson*	3A Jones
3A Lamar	2A Lanier*	3A Laurens*	3A Lee*
2A Liberty*	3A Lincoln	2A Long*	2A Lowndes*
4A Lumpkin	3A Macon*	3A Madison	3A Marion*
3A McDuffie	2A McIntosh*	3A Meriwether	2A Miller*
2A Mitchell*	3A Monroe	3A Montgomery*	3A Morgan
4A Murray	3A Muscogee	3A Newton	3A Oconee
3A Oglethorpe	3A Paulding	3A Peach*	4A Pickens
2A Pierce*	3A Pike	3A Polk	3A Pulaski*
3A Putnam	3A Quitman*	4A Rabun	3A Randolph*
3A Richmond	3A Rockdale	3A Schley*	3A Screven*
2A Seminole*	3A Spalding	4A Stephens	3A Stewart*
3A Sumter*	3A Talbot	3A Taliaferro	2A Tattnell*
3A Taylor*	3A Telfair*	3A Terrell*	2A Thomas*
3A Tift*	2A Toombs*	4A Towns	3A Treutlen*
3A Troup	3A Turner*	3A Twiggs*	4A Union
3A Upson	4A Walker	3A Walton	2A Ware*
3A Warren	3A Washington	2A Wayne*	3A Webster*
3A Wheeler*	4A White	4A Whitfield	3A Wilcox*
3A Wilkes	3A Wilkinson	3A Worth*	

INSULATION R-VALUES

Code Section

303.1, 402.1.2, 402.2

Description

All insulation installed within the building thermal envelope must have a label indicating the R-value, or it must have a certificate verifying the type of insulation, the thickness, and installed R-value.

A certificate for blown insulation must provide the installed density, coverage, and number of bags of insulation.

- For blown or sprayed insulation (fiberglass and cellulose), the initial installed thickness, settled thickness, settled R-value, installed density, coverage area, and number of bags installed must be listed on the certification.
- For sprayed polyurethane foam (SPF) insulation, the installed thickness of the areas covered and R-value of installed thickness must be listed on the certification.
- For insulated siding, the R-value must be labeled on the product's package and listed on the certification. The insulation installer must sign, date, and post the certification in a conspicuous location on the job site.

Markers/rulers:

- The thickness of blown or sprayed roof/ceiling insulation (fiberglass or cellulose) must be written in inches on markers that are installed at least one for every 300 sq. ft. throughout the attic space.
- The markers must be affixed to the trusses or joists and marked with the minimum initial installed thickness with numbers not less than 1 inch in height. Each marker must face the attic access opening.
- SPF thickness and installed R-value must be listed on certification provided by the insulation installer.



Blown insulation rulers installed 1 per 300 sq. ft. facing attic access

Insulation material used in layers (e.g., framing cavity insulation) or continuous insulation is summed to compute the corresponding component R-value. For blown insulation, refer to the manufacturer's settled R-value.

Computed R-values do not include an R-value for other building materials or air films. Where insulated siding is used to meet prescriptive requirements, the manufacturer's labeled R-value for insulated siding is reduced by R-0.6.

PASSING GRADE DETAILS

Excerpted from Appendix RA, 2015 IECC (2020 Georgia Energy Code)

Wall and Ceiling Insulation Installation

Wall and ceiling insulation that makes up portions of the building thermal envelope shall be installed to Passing Grade quality.

Two criteria affect installed insulation grading: **voids/gaps** (in which no insulation is present in a portion of the overall insulated surface) and **compression/incomplete fill** (in which the insulation does not fully fill out or extend to the desired depth).

Voids/Gaps

Voids or gaps in the insulation are < 1% of overall component surface area (only occasional and very small gaps allowed for Passing Grade).

Compression/Incomplete Fill

- Compression/incomplete Fill for both air permeable insulation (e.g., fiberglass, cellulose) and air impermeable insulation (e.g., spray polyurethane foam) must be less than 1 inch in depth or less than 30% of the intended depth, whichever is more stringent. The allowable area of compression/incomplete fill must be less than 2% of the overall insulated surface to achieve a Passing Grade.
- Any compression/incomplete fill with a **depth** greater than the above specifications (up to 1" or 30% of the intended depth, whichever is more stringent) shall not achieve a Passing Grade.

Additional Wall Insulation Requirements

- All vertical air permeable insulation shall be installed in substantial contact with an air barrier on all six (6) sides. Exception: Unfinished basements, rim/band joist cavity insulation, and fireplaces (insulation shall be restrained to stay in place). For unfinished basements, air permeable insulation and associated framing in a framed cavity wall shall be installed less than ¼" from the basement wall surface.
- Attic knee walls shall be insulated to a total R-value of at least R-18 through any combination of cavity and continuous insulation. Air permeable insulation shall be installed with a fully sealed attic-side air barrier (e.g., OSB with seams caulked, rigid insulation with joints taped, etc.). Attic knee walls with air impermeable insulation shall not require an additional attic-side air barrier.

Underfloor Insulation Installation

Underfloor insulation that makes up portions of the building thermal envelope shall be installed to Passing Grade quality.

Two criteria affect installed insulation grading: voids/ gaps (in which no insulation is present in a portion of the overall insulated surface) and compression/incomplete fill (in which the insulation does not fully fill out or extend to the desired depth).

Voids/Gaps

- Voids or gaps in the insulation are minimal for Passing Grade (< 2% of overall component surface area).

Compression/Incomplete Fill

- Compression/incomplete Fill for both air permeable insulation (e.g., fiberglass, cellulose) and air impermeable insulation (e.g., spray polyurethane foam) must be less than 1 inch in depth or less than 30% of the intended depth, whichever is more stringent. The allowable area of compression/incomplete fill must be less than 10% of the overall insulated surface to achieve a Passing Grade.
- Any compression/incomplete fill with a **depth** greater than the above specifications (up to 1" or 30% of the intended depth, whichever is more stringent) shall not achieve a Passing Grade.
- Air-permeable underfloor insulation shall be permanently installed against the subfloor decking. Adequate insulation supports (e.g., wire staves) for air-permeable insulation shall be installed at least every 18-24".

Exception: The floor framing-cavity insulation shall be permitted to be in contact with the topside of sheathing or continuous insulation installed on the bottom side of floor framing where combined with insulation that meets or exceeds the minimum wood frame wall R-value and that extends from the bottom to the top of all perimeter floor framing members.

SLAB EDGE INSULATION

Code Section 303.2.1, 402.1.2, 402.2.10

Code Value CZ2: R-0
CZ3: R-0
CZ4: R-10 @ 2ft depth (GA Amended to R-0)
Heated Slabs: Add R-5

Description

- Insulation for an unheated slab is not required in all of GA (CZs 2-4). For heated slabs in GA, add R-5.
- Insulation must start at the top surface of the slab and extend downward to completely cover the slab edge.
- Insulation on perimeter of slab-on-grade floors must have opaque, weather-resistant protective covering, which must cover exposed exterior insulation and extend at least 6 inches below grade.

Slab Edge Insulation Diagram*

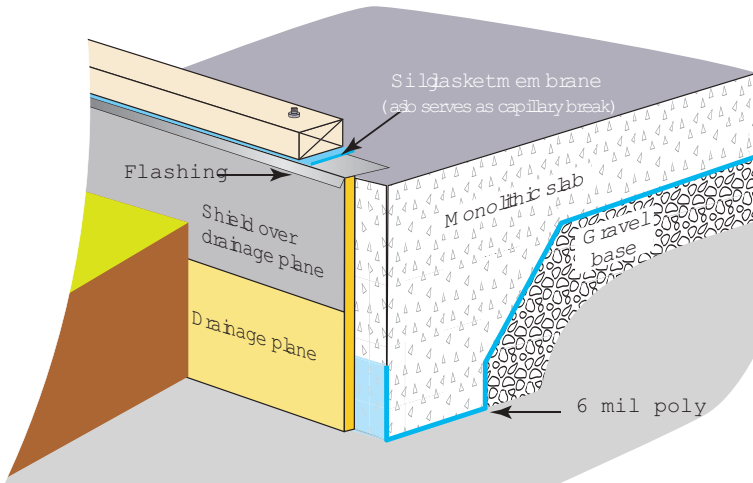

BASEMENT WALL INSULATION

Code Section 301.1, 303.2, 402.1.2, 402.1.4, 402.1.6, 402.2.7, 402.2.9, 402.4.1.1

Code Value CZ2: R-0
CZ3: R-5 Continuous (interior or exterior); or
R-13 Cavity (interior)
CZ4: R-10 Continuous; R-13 Cavity

Description

- A basement wall is at least 50% below grade.
- Insulation must be installed according to manufacturer's instructions. If installed on the exterior, code values listed above apply and insulation must have opaque, weather-resistant protective covering, which must cover exposed above-grade exterior insulation and extend at least 6 inches below grade.
- Basement wall insulation may also be applied in an interior wall cavity (R-13 for CZs 3-4).
- Alternately, the floor over the basement may be air sealed and insulated (for an unconditioned basement only).
- Interior insulation must extend to the basement floor or to 10 feet, whichever is less.
- Indirectly conditioned basements must meet same wall insulation requirements.

Note: When trade-offs are used, minimum R-value for basement walls is R-0 in CZ2 and R-5 in CZs 3-4.

Basement Wall Insulation Details

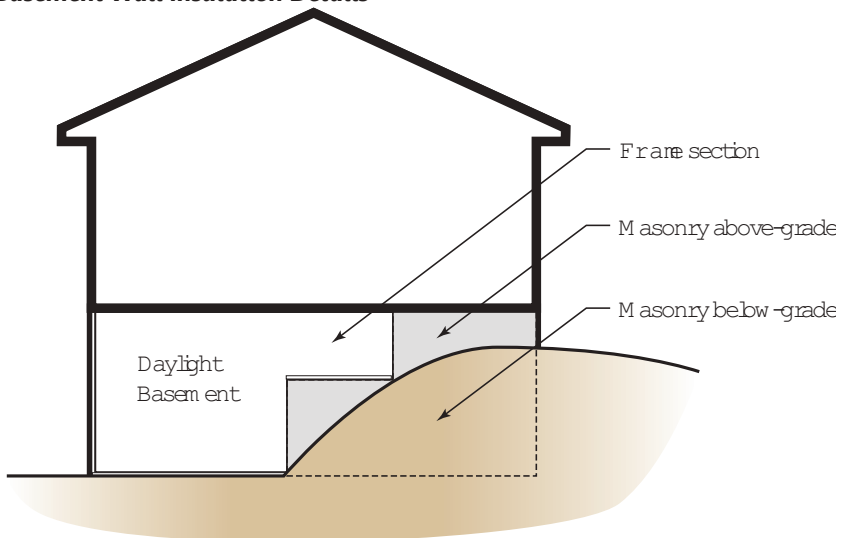

Basement Wall Insulation Details, continued



Insulation installed in full contact with wall.



INCORRECT (CZ3-4): Insulation not on concrete portion of basement wall.



Insulated concrete form exceeds code by providing continuous insulation on interior and exterior of foundation.

Basement Wall Insulation Details, continued

Important Note: A 3-inch inspection/view strip immediately below the floor joists must be provided for termite inspection. Diagrams on this page do not show this strip; see p.17 (Crawl Space) for illustration.

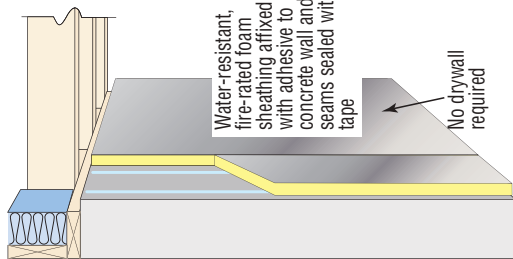

Rigid board with fire-rated foam

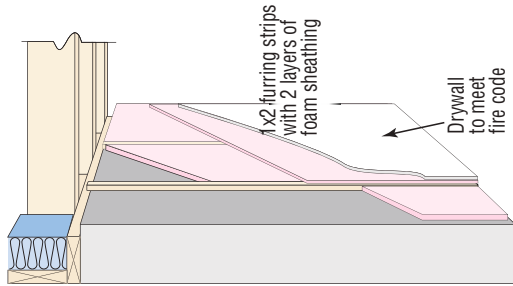

Rigid board with drywall

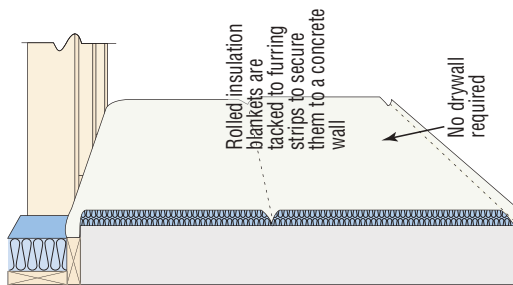

Blanket batts

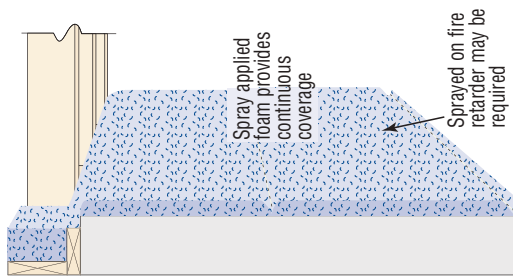

Spray applied foam

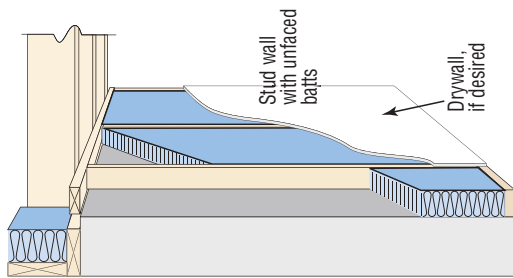

Batts in cavities

CRAWL SPACE WALL INSULATION

Code Section 303.2, 402.1.2, 402.1.4, 402.1.6, 402.2.11, 402.4.1.1, IRC408

Code Value CZ2: R-0
CZ3: R-5 Continuous; R-13 Cavity
CZ4: R-10 Continuous; R-13 Cavity

Description

- Closed (conditioned) crawlspaces may have the walls insulated instead of overhead floors if the crawlspace is not vented from the outside and the details of the IRC for unvented crawlspaces are met (e.g., conditioning the crawlspace via a supply duct or a dedicated dehumidifier).
 - Floors above a ventilated (unconditioned) crawlspace must be insulated to R-19 in CZs 3-4 and R-13 in CZ2.
 - Insulation on the exterior of unvented, conditioned crawlspace walls must have rigid, opaque, weather-resistant covering, which must cover exposed exterior insulation and extend at least 6 inches below grade.
 - Insulation on the interior of unvented, conditioned crawlspace walls must be permanently fastened to the wall and extend downward from the bottom of the floor framing to within zero to 9 inches of finished grade.
 - A 3-inch inspection/view strip immediately below the floor joists must be provided for termite inspection. An optional, removable (for inspection purposes) 3-inch “plug” of insulation may be inserted for a more complete insulation coverage.
 - The band area of a conditioned crawlspace must be air sealed and insulated. It is strongly recommended that the band area be insulated with a removable insulation product to provide access for pest control inspection.
 - See also “Crawl Space Vapor Retarder” and “Access Hatches and Doors.”
- Note: If trade-offs are used, minimum R-5 insulation applies for CZs 3-4.

Crawl Space Wall Insulation Diagram

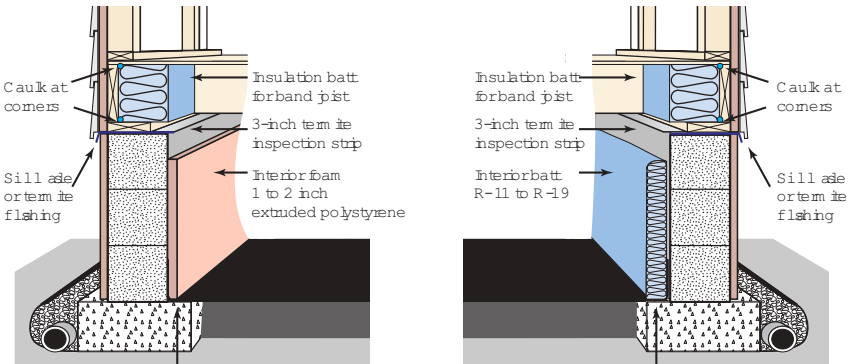

CRAWL SPACE VAPOR RETARDER

Code Section

402.1.1, 402.2.11

Description

- Exposed earth in an unvented crawl space must be covered by a continuous Class I vapor retarder in accordance with IBC or IRC.
- All joints of the vapor retarder must overlap by 6 inches and be sealed or taped. The edges must extend at least 6 inches up the stem wall and be attached to the stem wall.
- A Class I vapor retarder must be applied to the entire floor and run at least 6 inches up the walls of the crawl space and sealed to the walls. Any seams in the vapor retarder must have at least a 6-inch overlap and be sealed or taped. See Crawl Space Wall Insulation for diagram of vapor retarder sealing.

Notes: A Class I vapor retarder has a perm rating of less than 0.1 perm (such as 6-mil polyethylene). The IECC only requires a vapor retarder for unvented, conditioned crawlspaces, but the IRC requires a vapor retarder for both vented and unvented crawlspaces unless the crawlspace is “highly vented.”

The energy code requires a vapor retarder for unvented crawlspaces. The 2018 IRC 408.1 does not require a vapor retarder for a “highly vented” crawl space (where ventilation is provided at not less than 1 sq. ft. per 150 sq. ft. of under-floor space area). Ventilation area may be decreased to 1 sq. ft. per 1,500 sq. ft. with a Class I vapor retarder. See “Crawl Space Wall Insulation” for insulation details.

Sealing and Overlapping Vapor Retarder



Sealed and overlapped seams



Sealed and applied 6" up wall

FLOOR INSULATION

Code Section 303.2, 402.1.2, 402.1.4, 402.1.6, 402.2.6, 402.2.8

Code Value CZ2: Wood: R-13
Steel*: R-19 in 2x6;
R-19+R-6 in 2x8 or 2x10
CZ3: Wood: R-19
Steel*: R-19+R-6 in 2x6;
R-19+R-12 in 2x8 or 2x10
CZ4: Same as CZ3

*Cavity insulation R-value is listed first, followed by continuous insulation R-value.

Description

- Floor insulation must be installed on any wood-framed, steel-framed, or raised concrete floor that is part of the building thermal envelope.
- Floor insulation must be installed in accordance with the manufacturer's installation instructions and in permanent continuous contact with the underside of the subfloor decking.
- As an exception, the floor framing-cavity insulation shall be permitted to be in contact with the topside of sheathing or continuous insulation installed on the bottom side of floor framing where combined with insulation that meets or exceeds the minimum wood-frame wall R-value in Table 402.1.2 and extends from the bottom to the top of all perimeter floor framing members.
- Cantilevered floors over the outdoors must be R-30, and the band area above the exterior wall must be blocked.
- Vapor retarders are not required for floor insulation in CZs 2-4

Note: If trade-offs are used, minimum insulation value for floors over unheated spaces is R-13.

Floor Assembly Details

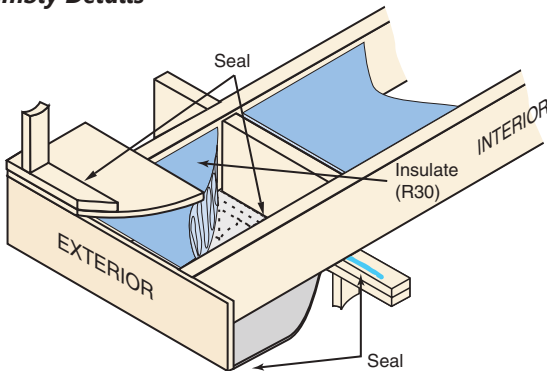

Floor Insulation Details, continued

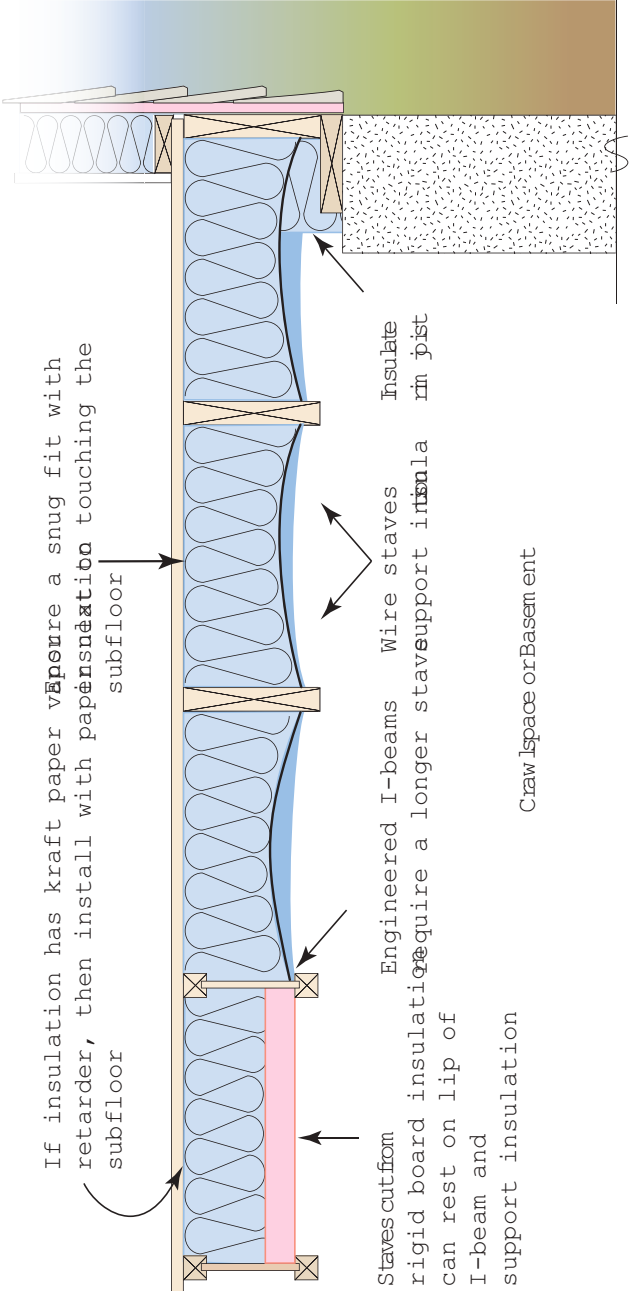

If insulation has kraft paper vapour retarder, then install with vapour retarder touching the subfloor

Staves cut from rigid board insulation can rest on lip of I-beam and support insulation

WALL INSULATION

Code Section 303.2, 402.1.2, 402.1.4, 402.1.5, 402.1.6, 402.2.5, 402.2.6, 402.2.13

Code Value CZ2: Wood: R-13
Steel*: R-13+4.2 or R-19+2.1; R-21+2.8;
R-0+9.3; R-15+3.8; R-21+3.1
CZ3: Wood: R-20 or R-13+5 (GA Amended to R-13)
Steel*: R-0+14.0 or R-13+8.9; R-15+8.5;
R-19+7.8; R-19+6.2; R-21+7.5
CZ4: Same as CZ3

*Cavity insulation R-value is listed first, followed by continuous insulation R-value.

Description

- Insulation must be applied to wood-frame, steel-frame, and mass walls that are above grade and associated with the building thermal envelope.
- Mass walls are those of concrete block, concrete, ICFs, masonry cavity, brick (non-veneer), earth/adobe, and solid timber/logs. See "Mass Wall Insulation" for more details.
- Wall insulation must be installed in accordance with the manufacturer's installation instructions, and all places in the wall that will accommodate insulation must be insulated.
- Insulation in sunroom walls (rooms thermally isolated from conditioned space) must meet these criteria.
- Vapor retarders are not required for wall insulation in CZs 2-4.

Note: If trade-offs are used, minimum insulation value for cavity (stud) walls is R-13 and minimum insulation for mass walls is R-4 in CZ2, R-5 in CZs 3-4.

Wall Insulation Details



CORRECT: Batt in wood-framed cavity



INCORRECT: Unfilled cavity



CORRECT: Full coverage/no compression



INCORRECT: Compression/poor coverage

Wall Insulation Details, continued

Excerpted from Appendix RA, 2015 IECC (2020 Georgia Energy Code)

Wall Insulation key points

Voids / Gaps

Passing Grade 

Insulation is notched and completely surrounds electrical box

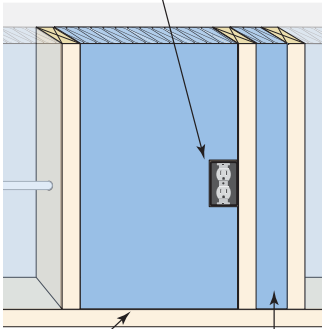

Insulation fully fills cavity at top and bottom

Narrow cavity fully insulated

Unacceptable Installation 

Incomplete insulation coverage around electrical box

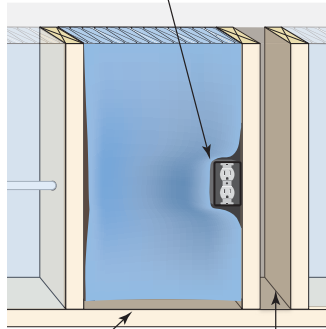

Insulation does not extend to bottom of cavity

Narrow cavity not insulated

Compression / Incomplete Fill

Passing Grade 

Insulation is slit around electrical wire

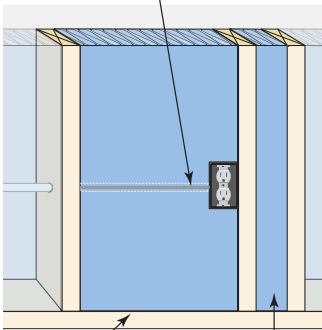

Insulation extends from front to back and fully fills entire cavity

Proper width insulation fully fills narrow cavity

Unacceptable Installation 

Insulation is compressed behind electrical wire

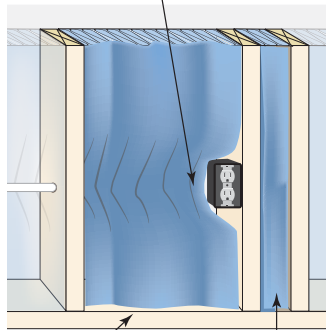

Insulation does not fully fill entire cavity

Improper width insulation is compressed into narrow cavity

MASS WALL EXTERIOR AND INTERIOR INSULATION

Code Section 303.2, 402.1.2, 402.1.4, 402.1.6, 402.2.5

Code Value CZ2: R-4; R-6 interior insulation
CZ3: R-8; R-13 interior installation
CZ4: Same as CZ3

Description

- Above-grade mass walls are those of concrete block, concrete, ICFs, masonry cavity, brick (non-veneer), earth/adobe, and solid timber/logs.
- An above-grade mass wall is one that is more than 50% above grade. If the wall is at least 50% below grade, see "Basement Wall Exterior Insulation" requirements.
- Mass wall insulation must be installed in accordance with the manufacturer's installation instructions.
- If more than half the insulation is on the interior, the mass wall interior insulation requirement applies.

Note: If trade-offs are used, minimum insulation for mass walls is R-4 in CZ2 or R-5 in CZs 3-4.

Insulated Concrete Forms

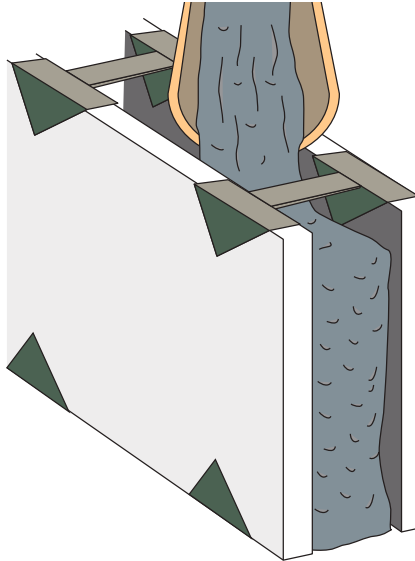

Above-grade Insulated Concrete Forms (ICFs) are considered mass walls and typically greatly exceed prescriptive code R-values

CEILING INSULATION

Code Section 303.1.2, 303.2, 303.1.1, 303.1.1.1, 402.1.2, 402.1.4, 402.1.5, 402.1.6, 402.2.1, 402.2.2, 402.2.6, 402.2.13

Code Value CZ2: R-38
CZ3: R-38
CZ4: R-49 (GA Amended to R-38)

*See 2015 IECC, Table R402.2.6 for equivalent R-values for steel components.

Description

- For blown-in attic insulation, rulers must be provided for every 300 sq. ft. of attic space and face the attic access. See "Insulation R-Values" for more details.
- Where R-38 value would be required in ceilings, R-30 insulation is permissible if it is installed across 100% of the attic floor, including full coverage of the top plate at the eaves. See diagram.
- For attic HVAC platforms, R-19 is acceptable to meet the requirements of R-30/R38 in the ceiling for up to 32 sq. ft. of attic decking per HVAC system. R-19 is also acceptable underneath a maximum 32-inch wide passage to the HVAC system.
- Insulation in sunroom ceilings (rooms thermally isolated from conditioned space) must meet these criteria.
- All insulation must be installed in accordance with the manufacturer's installation instructions.
- See "Wind Wash Baffles and Air Permeable Insulation Dams," "Access Hatches and Doors," and "Attic Kneewalls" for more details, if applicable.
- For vaulted ceilings, R-30 minimum is acceptable up to 500 sq. ft. or 20% of the total attic space (whichever is less). This reduction does not apply to the U-factor or UA alternative approaches.
- Vapor retarders are not required for ceiling insulation in CZs 2-4.

Note, if trade-offs are used:

- The minimum insulation value for ceilings with attic spaces is R-30.
- For unvented attics with air-permeable (fiberglass or cellulose) insulation installed on the roofline, a minimum of R-20 insulation and additional R-5 air-impermeable insulation is required in CZs 2-3. In CZ4, R-15 air-impermeable insulation must be installed in addition to the R-20 air-permeable insulation.
- For unvented attics where air-impermeable insulation is installed on the roofline, R-20 is the minimum.
- See Appendix RA of the *Georgia State Amendments* for additional technical illustrations of roofline installed insulation requirements.

Roofline Impermeable Insulation Assembly (minimum R-20)

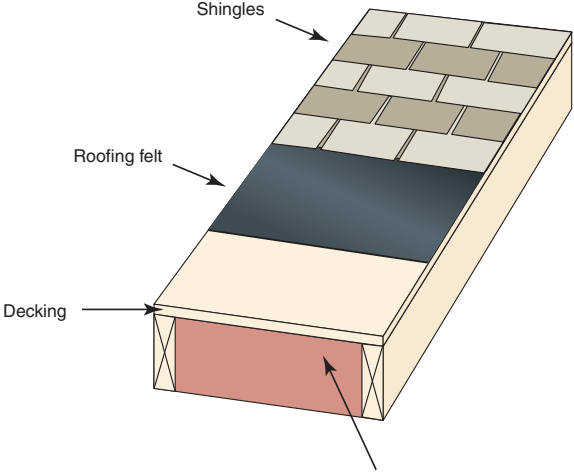

Air impermeable insulation
(e.g., open- or closed-
cell spray foam)

Spray Foam Application



WIND WASH Baffle AND AIR-PERMEABLE INSULATION DAM

Code Section

402.2.3

Description

- For air-permeable insulation (fiberglass or cellulose insulation) in vented attics, baffles must be installed adjacent to soffit and eave vents.
- At a minimum, 1 inch of space must be provided between the insulation and the roof sheathing and at the location of the vent.
- The baffle must extend over the top of the insulation inward until it is at least 4 inches vertically above the top of the insulation.
- Any solid material such as cardboard or thin insulating sheathing is permissible as the baffle /insulation dam.

Baffle Installation

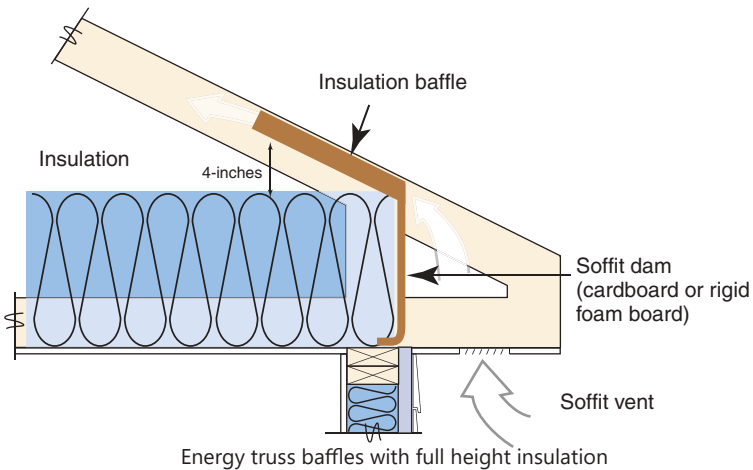

Baffle Installation, continued

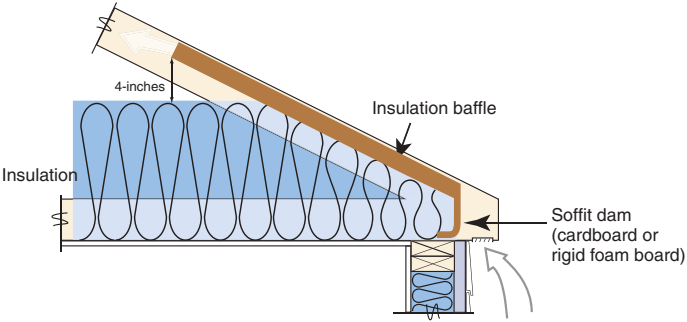

Standard truss baffles with tapered insulation depth

Insulation Baffles



Baffles (pre-insulation) extended over top-plate

ACCESS HATCHES AND DOORS

Code Section 402.2.4, 402.4.1, 402.4.1.1

Code Value Hatches/Scuttle-Hole Covers: R-19
 Vertical Kneewall Door: R-5
 Attic Pull-Down Stairs: R-5

Description

- All accesses between conditioned and unconditioned space must be insulated and air-sealed (weather stripped).
- A wood-framed or equivalent baffle or retainer is required where loose-fill insulation is installed, such as around pull-down stairs in an insulated ceiling. The purpose is to prevent the loose-fill insulation from spilling into the living space when the attic access is opened and to provide a permanent means of maintaining the installed R-value of the loose fill insulation.

Hatches and Doors Diagram

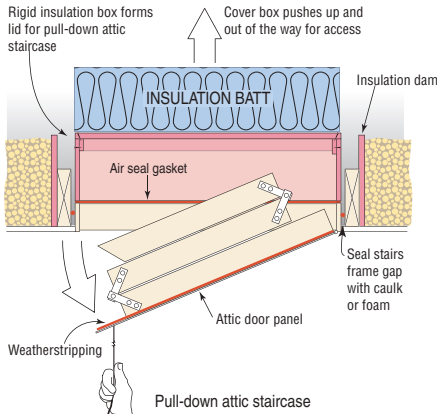

Attic pull-down stairs

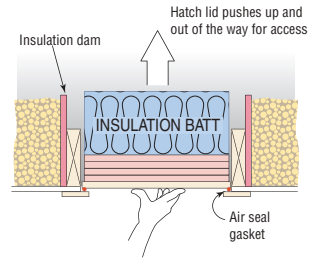

Attic access hatch with batt insulation

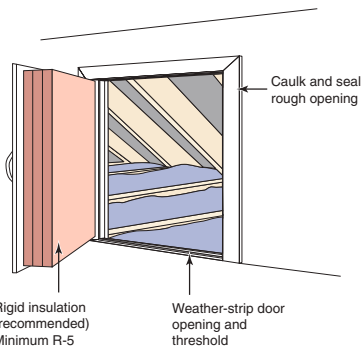

Attic kneewall door

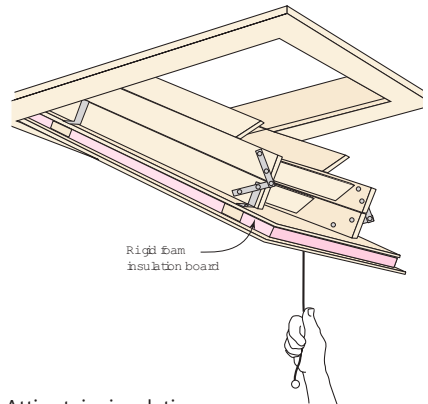

Attic stairs insulation

Hatches and Doors, continued



INCORRECT - This pull-down stairs needs air sealing in the rough opening.



This pull-down stairs features R-5 insulation in the door as well as an R-5 insulated cover box (either option will satisfy code).

ATTIC KNEEWALLS

Code Section Chapter 2 (Definitions), 402.1.2, 402.1.4, 402.1.6, 402.4.1.1

Code Value CZs 2-4: R-18 with sealed attic-side air barrier

Description

- An attic kneewall is defined as any vertical or near-vertical wall in the building envelope that has conditioned space on one side and attic space on the other side.
- All attic kneewalls must be insulated to at least R-18 and air-sealed. Attic kneewalls may be insulated using R-13+R-5 insulated sheathing, R-15+R-3 insulated sheathing, or R-19 compressed into a 2×6 cavity with a sealed attic-side air barrier.
- The attic side of the kneewall must have an attached air barrier (with all seams and edges sealed). The top and bottom of the kneewall stud cavity must be blocked and sealed to fully encapsulate insulation.
- Sprayed polyurethane foam in an attic kneewall serves as the air barrier.

Note: If trade-offs are used, minimum insulation value for attic kneewalls is R-18 with attic-side air barrier.

Blocking and Sealing Attic Kneewalls

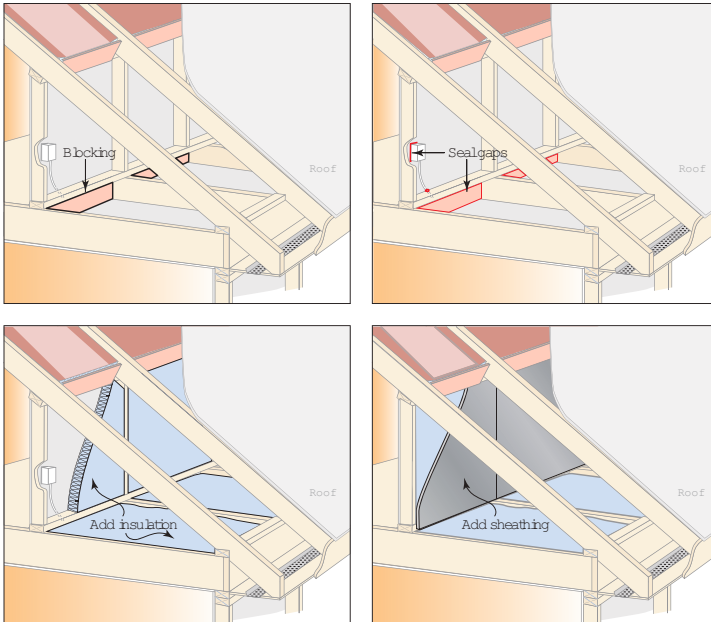

Kneewall Air-Sealing and Insulation Details

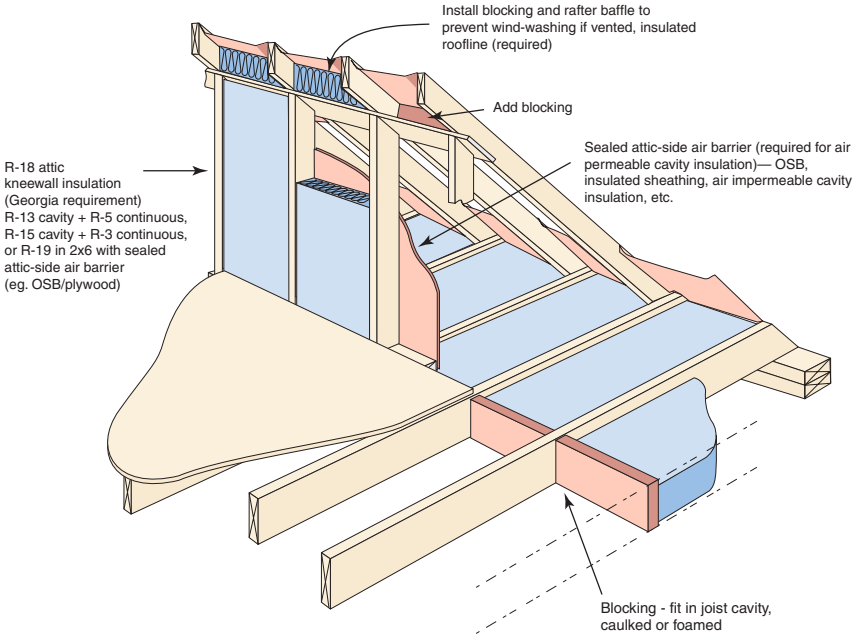

Blocking and Sealing Attic Kneewalls



INCORRECT: Unblocked joist cavity. Inspector is reaching through the unblocked joist cavity revealing a significant pathway for unconditioned attic air into the building envelope.



CORRECT: Blocked joist cavity/sealed attic-side air barrier

FENESTRATION U-FACTOR

Code Section 303.1.3, 402.1.2, 402.1.4, 402.1.5, 402.1.6, 402.3, 402.4.3, 402.5

Code Value CZ2: 0.35 (GA Amendment)
 CZ3: ~~U-0.40~~ (GA Amended to U-0.35)
 CZ4: ~~U-0.40~~ (GA Amended to U-0.35)

Description

- An area-weighted average can be used to satisfy the U-factor requirement.
- For the prescriptive approach only, up to 15 sq. ft. of the total glazed fenestration (including skylights) do not have to meet the specified U-factor in the code.
- Glazing must be labeled and certified to meet NFRC standards. If glazing is not NFRC certified, default values in Table 303 must be used, but these default values are poor and will not meet prescriptive requirements in the energy code.
- Under the prescriptive approach only, up to 24 sq. ft. of side-hinged door does not have to meet the specified U-factor in the code. This exemption does not apply to attic access doors.
- For enclosed, thermally isolated sunrooms, maximum 0.45 U-factor is allowed. New fenestrations separating sunrooms and conditioned space must meet code value(s) listed.

Note: If trade-offs are used, the maximum U-factor is 0.50 for windows in CZs 2-4.

NFRC Glazing Label (Highlighting U-Factor)

 <small>NFRC National Fenestration Rating Council®</small> CERTIFIED	World's Best Window Co. Millennium 2000+ <small>Vinyl-Clad Wood Frame Double Glazing - Argon Fill - Low E</small> Product Type: Vertical Slider	
	ENERGY PERFORMANCE RATINGS	
U-Factor (U.S./I-P)	Solar Heat Gain Coefficient	
0.35	0.30	
ADDITIONAL PERFORMANCE RATINGS		
Visible Transmittance	Air Leakage (U.S./I-P)	
0.51	0.2	
Condensation Resistance		
51	—	
<small>Manufacturer stipulates that these ratings conform to applicable NFRC procedures for determining whole product performance. NFRC ratings are determined for a fixed set of environmental conditions and a specific product size. NFRC does not recommend any product and does not warrant the suitability of any product for any specific use. Consult manufacturer's literature for other product performance information. www.nfrc.org</small>		

SKYLIGHT U-FACTOR

Code Section 303.1.3, 402.1.2, 402.1.4, 402.4.3, 402.5

Code Value CZ2: U-0.65
CZ3: U-0.55
CZ4: U-0.55

Description

- Glazing that is at least 15 degrees from vertical installed in the building envelope is subject to this requirement.
- For the prescriptive approach only, up to 15 sq. ft. of total glazed fenestration (including skylights) do not have to meet the specified U-factor.
- An area-weighted average can be used to satisfy the skylight U-factor requirement.
- Glazing must be labeled and certified as meeting NFRC standards. If not, default values in Table R303.1.3 must be used, but these default values are poor and will not meet the code's prescriptive requirements.
- For enclosed, thermally isolated sunrooms, maximum 0.7 U-factor is allowed.

Note: If trade-offs are used, maximum U-factor is 0.5 for windows in CZs 2-4.

Skylights



SOLAR HEAT GAIN COEFFICIENT (SHGC) VALUES FOR GLAZED FENESTRATION AND SKYLIGHTS

Code Section 303.1.3, 402.1.2, 402.1.4, 402.1.5, 402.3.2, 402.3.5

Code Value CZ2: SHGC-0.25 0.27 (GA Amendment)
 CZ3: SHGC-0.25 0.27 (GA Amendment)
 CZ4: SHGC-0.40 0.27 (GA Amendment)

Description

- An area-weighted average of fenestration products over 50 percent glazed can be used to satisfy the SHGC requirement.
- For the prescriptive approach only, up to 15 sq. ft. of glazed fenestration does not have to meet the specified SHGC requirement. Glazing must be labeled and certified as meeting NFRC standards.
- If glazing is not NFRC certified, default values in Table R303.1.3 must be used, but these default values are poor and will not meet prescriptive requirements.
- In CZs 2-3, skylights may be excluded from SHGC requirements if skylight SHGC does not exceed 0.30. (See Table R402.1.2, footnote B.)

Note: If trade-offs are used, maximum SHGC is 0.30 for windows.

NFRC Glazing Label (Highlighting SHGC)

 National Fenestration Rating Council® CERTIFIED	World's Best Window Co. Millennium 2000+ Vinyl-Clad Wood Frame Double Glazing • Argon Fill • Low E Product Type: Vertical Slider	
	ENERGY PERFORMANCE RATINGS	
U-Factor (U.S./I-P)	Solar Heat Gain Coefficient	
0.35	0.30	
ADDITIONAL PERFORMANCE RATINGS		
Visible Transmittance	Air Leakage (U.S./I-P)	
0.51	0.2	
Condensation Resistance		
51	—	
<small>Manufacturer stipulates that these ratings conform to applicable NFRC procedures for determining whole product performance. NFRC ratings are determined for a fixed set of environmental conditions and a specific product size. NFRC does not recommend any product and does not warrant the suitability of any product for any specific use. Consult manufacturer's literature for other product performance information. www.nfrc.org</small>		

FENESTRATION AIR LEAKAGE

Code Section 402.4.3

Code Value Max 0.3 CFM/sq.ft.
(0.5 CFM/sq.ft. for swinging doors)

Description

- Each window, skylight, and sliding glass door must be tested to the referenced NFRC 400 or AAMA/WDMA/CSA standards and meet the required air-infiltration rate.
- Each window, skylight, and sliding glass door must have a manufacturer's label, seal, symbol, or other identifying mark indicating the test results or compliance with the code.
- Site-built windows, skylights, and doors are exempt from this requirement (but must comply with sealing requirements).

NFRC Glazing Label (Highlighting Air Leakage)

 <small>National Fenestration Rating Council®</small> CERTIFIED	World's Best Window Co. Millennium 2000+ Vinyl-Clad Wood Frame Double Glazing • Argon Fill • Low E Product Type: Vertical Slider	
	ENERGY PERFORMANCE RATINGS	
U-Factor (U.S./I-P)	Solar Heat Gain Coefficient	
0.35	0.30	
ADDITIONAL PERFORMANCE RATINGS		
Visible Transmittance	Air Leakage (U.S./I-P)	
0.51	0.2	
Condensation Resistance		
51	—	
<small>Manufacturer stipulates that these ratings conform to applicable NFRC procedures for determining whole product performance. NFRC ratings are determined for a fixed set of environmental conditions and a specific product size. NFRC does not recommend any product and does not warrant the suitability of any product for any specific use. Consult manufacturer's literature for other product performance information. www.nfrc.org</small>		

IC-RATED RECESSED LIGHTING FIXTURES (SEALING)

Code Section

402.4.1.1, 402.4.5

Description

- Recessed lighting fixtures inside the building thermal envelope must be sealed to limit air leakage between conditioned and unconditioned space.
- Fixtures must be IC-rated and labeled with an air leakage rate ≤ 2.0 CFM.
- Recessed fixtures must have a gasket or caulk between the housing and the interior finish.

Recessed Lighting Fixture Diagram

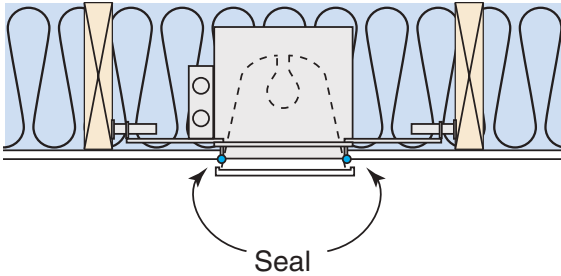

INCORRECT: Standard fixture



CORRECT: IC-rated and air-tight

AIR-SEAL AND INSULATE TUBS AND SHOWERS

Code Section

402.1.2, 402.4.1, 402.4.1.1

Description

- Insulation and a sealed air barrier must be installed between showers/tubs on an insulated (usually exterior) wall.
- All plumbing penetrations must be appropriately air-sealed.

Tub Air-Sealing and Insulation Diagram

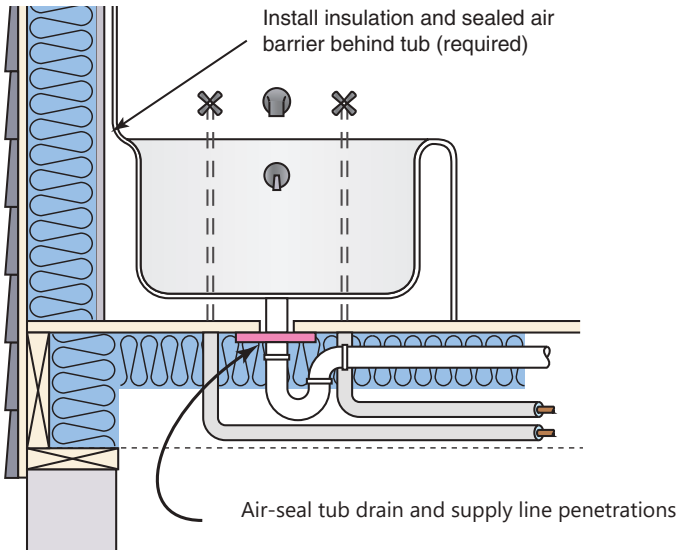

Air-Sealing Tubs and Showers



CORRECT: Air barrier and insulation behind tub



INCORRECT: Drain penetration open

AIR-SEAL WINDOW/DOOR OPENINGS

Code Section

402.4.1, 402.4.1.1

Description

Gaps between window/door jambs and framing must be sealed (e.g., with low expanding foam or backer rod). This includes skylights and attic access doors.

Air-Sealing Windows

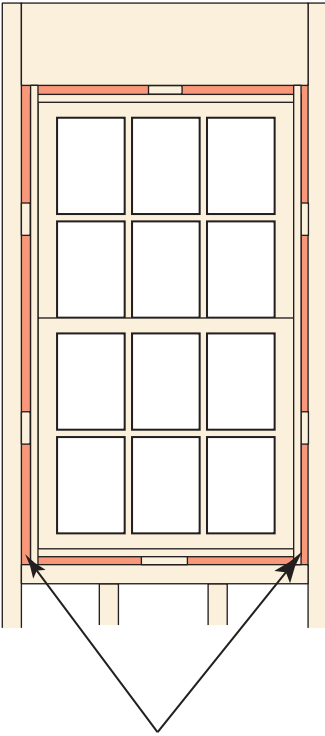

Use backer rod or low expanding spray foam (appropriate for windows) to fill gaps between window/door and rough opening

Window air-sealing



Air-sealing with backer rod



Air-sealing with spray foam

AIR-SEAL ASSEMBLIES SEPARATING GARAGE

Code Section

402.4.1, 402.4.1.1

Description

Walls and ceilings separating the garage from conditioned space must be air-sealed as well as insulated. For example, all floor joists and penetrations above an attached garage must be blocked and sealed.

Air-Sealing Assembly for Garage

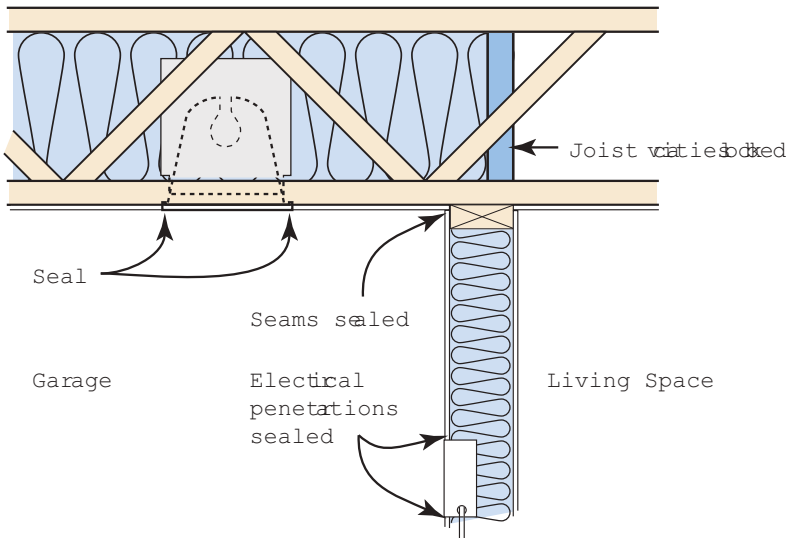

INCORRECT: Air bypass behind stairs



CORRECT: Joist cavities blocked

AIR-SEAL BOTTOM AND TOP PLATES

Code Section

402.4.1, 402.4.1.1

Description

- Bottom plates of walls separating conditioned and unconditioned spaces must be sealed to subfloor or foundation using caulk, adhesive, or gasket material.
- All joints, seams, and penetrations must be sealed. For example, plumbing and electrical penetrations through plates must be caulked or foamed.
- Top plate must be sealed to drywall at all interfaces between unconditioned attic and wall. Sealant may be applied from attic side to joints between drywall and top plate.

Air-Sealing Top/Bottom Plate

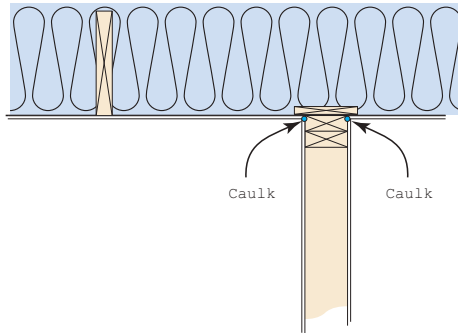

Bottom plate sealed to subfloor with caulk or gasket



Ceiling drywall sealed to top plate from attic side

Air-Sealing Top/Bottom Plate

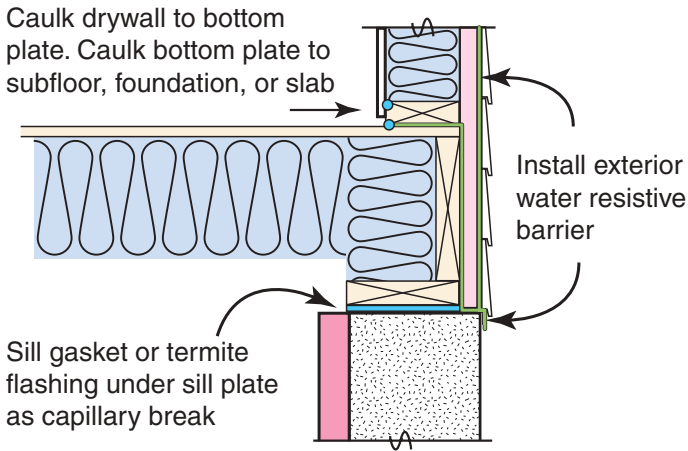
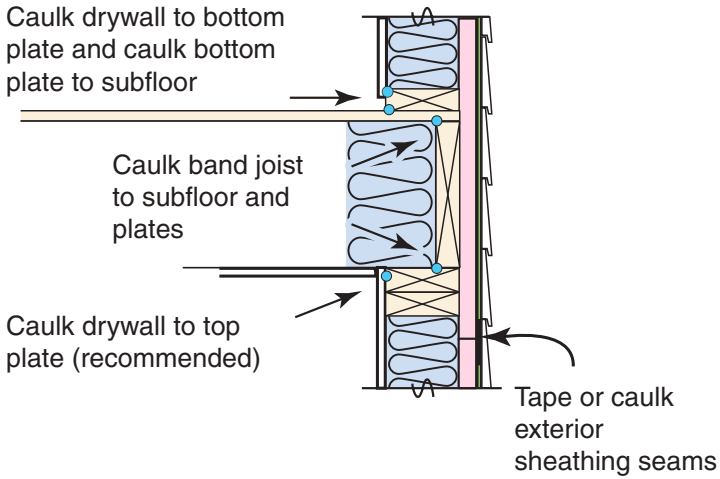

AIR-SEAL SEAMS IN EXTERIOR AIR BARRIER

Code Section

402.4, 402.4.1, 402.4.1.1

Description

- All joints, seams, and penetrations must be sealed. For example, gaps in exterior sheathing must be sealed with appropriate sealant. If house wrap is used as the air barrier, all edges, seams, and penetrations must be taped/sealed.

Sealing Sheathing or House Wrap



CORRECT: Tape seams in house wrap



CORRECT: Sealing exterior sheathing



Sheathing seams properly sealed

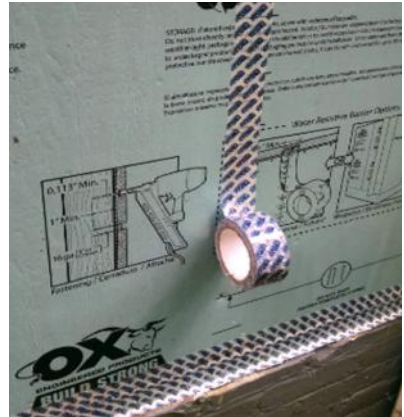

AIR-SEAL UTILITY PENETRATIONS

Code Section

402.4.1, 402.4.1.1

Description

- All utility penetrations in areas separating conditioned/unconditioned space must be air-sealed. This includes sealing all penetrations from plumbing, wiring, ductwork, exhaust fans, light fixtures, and electrical boxes through top and bottom plates, exterior sheathing, band and rim joists, insulated walls, insulated ceilings, and insulated subfloors.

Air-Sealing Penetrations Details



INCORRECT: Unsealed sheathing penetration



CORRECT: Air-sealed utility penetrations

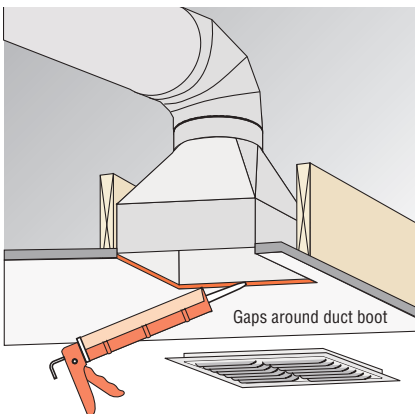

Duct boot penetration sealing

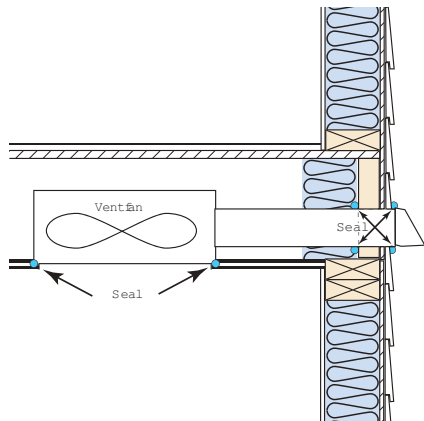

Band joist penetration sealing

AIR-SEAL DROPPED SOFFIT CEILINGS AND CHASES

Code Section

402.4.1, 402.4.1.1

Description

- Framed spaces connecting conditioned and unconditioned areas above and below a chase (e.g., attics, unconditioned basements, vented crawl spaces) must be air-sealed (e.g., with sheet material and proper sealant). These areas include chases for plumbing, ductwork, chimneys, and flues.
- Dropped ceilings or soffits between conditioned areas and the attic must also be air-sealed.

Proper Air-Sealing for Chases

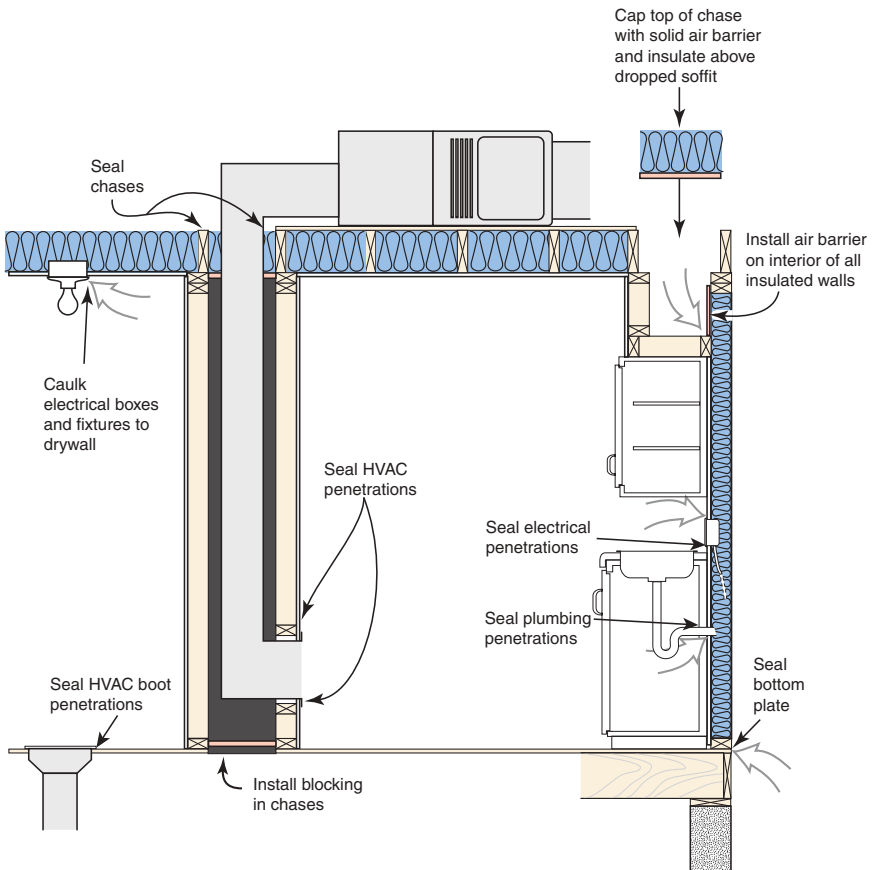

Air-Seal Dropped Ceilings and Chases



INCORRECT: Unsealed chase



CORRECT: Well-sealed chase



INCORRECT: Improperly capped chase



CORRECT: Capped chase properly sealed

AIR-SEAL RIM/BAND JOIST JUNCTIONS

Code Section

402.4.1, 402.4.1.1

Description

- All penetrations (e.g., from holes drilled for HVAC lines, plumbing lines, bathroom fans, exhaust fans, and electrical lines) through the rim/band joist between conditioned and unconditioned spaces must be sealed.
- Seal all seams in rim/band joist sheathing separating conditioned and unconditioned spaces between conditioned floors.
- Rim/band joist should be sealed to top plate, subfloor, and at butt joints (or at exterior sheathing).

Sealing Joist Penetrations

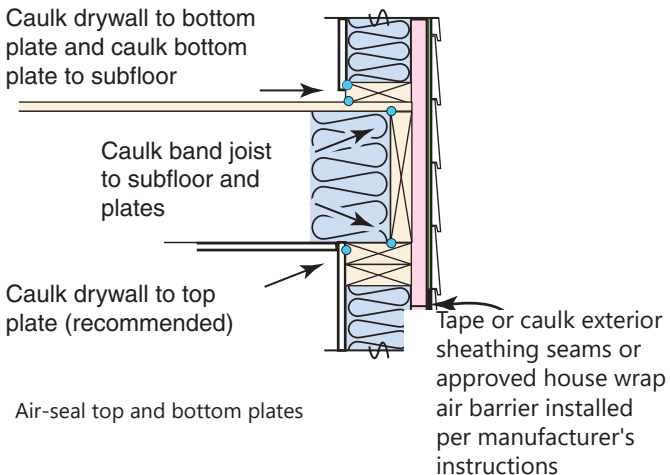

HVAC PIPING INSULATION

Code Section 403.4, 403.4.1, IRC M1411.5

Code Value R-3 (R-4 for suction lines)

Description

- Mechanical system piping capable of carrying fluids above 105°F or below 55°F must be insulated to a minimum of R-3. (Typically, a half-inch of insulation is equivalent to R-3.)
- Exposed piping insulation must be protected from the elements, including potential damage caused by UV from sunlight, wind, moisture, and home/yard maintenance. Adhesive tape is not permitted.

Note: IRC Section M-1411.5 requires R-4 for refrigerant suction lines.

HVAC Piping Insulation



HOT WATER PIPE INSULATION

Code Section 403.4, 403.4.1, 403.5.3

Code Value R-3

Description

Meeting the prescriptive energy code requires hot water piping insulation of R-3 value or greater, applied to the following:

- Piping with nominal diameter of $\frac{3}{4}$ -inch (19.1mm) and larger
- Piping that serves more than one dwelling unit
- Piping located outside the conditioned space
- Piping from the water heater to a distribution manifold
- Piping under a floor slab
- Buried piping
- Supply and return piping in recirculation systems (except demand recirculation systems)

Hot Water Pipe Insulation

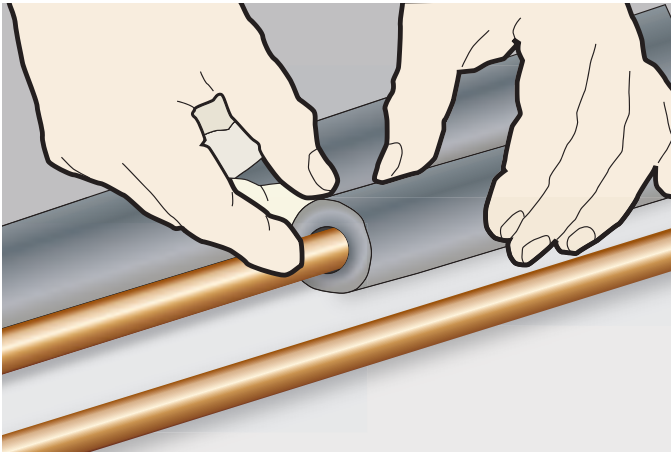

SERVICE HOT WATER SYSTEMS

Code Section

403.5, 403.5.1, 403.5.2

Description

- Heated water circulation systems must have a circulation pump. The return must be a dedicated return pipe or a cold water supply.
- Control should start based on identification for demand within the dwelling and automatically turn off when the water in the loop reaches desired temperature and there is no demand for hot water.
- Heat trace systems must comply with IEEE 515.1 or UL 515.
- A demand recirculation system has one or more recirculation pumps that pump water from a heated supply pipe back to the heated water source.
- Controls for a demand recirculation system start the pump upon receiving a signal or sensing the presence of a user or flow of hot/tempered water to a fixture or appliance.
- Controls for demand recirculation systems must limit the temperature of water entering the cold water piping to 104°F.
- Hot water piping insulation is prescriptively required for all recirculation systems (except demand-based controlled ones).

Hot water recirculation diagram

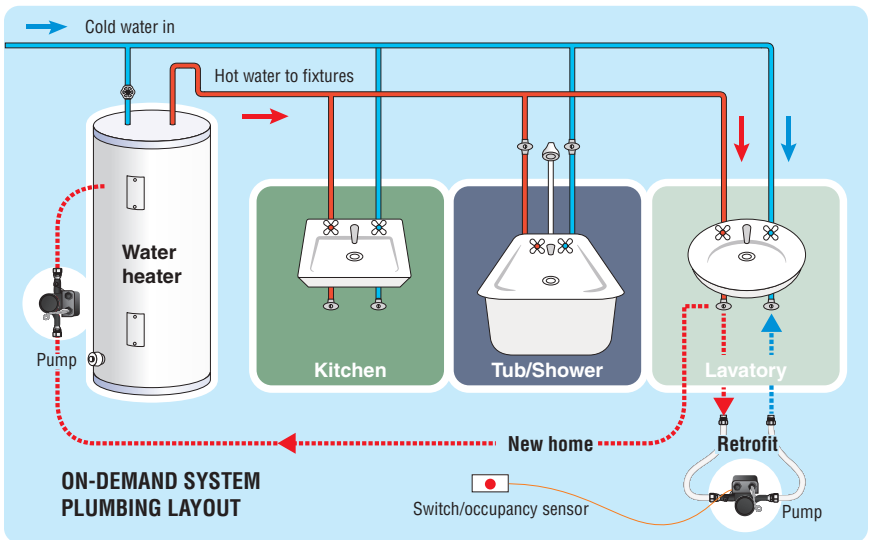

Hot water recirculation diagram showing optional return line (dashed)

DUCT INSULATION

Code Section 403.3.1

Code Value Attic Supply/Return: R-8 (3" diameter or greater); R-6 (<3" diameter)
Other Supply/Return: R-6 (3" diameter or greater); R-4.2 (<3" diameter)

Description

- R-value(s) apply to ducts that are outside the building thermal envelope. Ducts within conditioned space are not required to be insulated for energy code; however, insulating these ducts reduces the risk of condensation and is strongly recommended.
- Supply and return ducts in an unconditioned attic must be R-8. Other insulation requirements apply to supply and return ducts in unconditioned spaces outside the attic, such as an unconditioned basement or crawlspace.

R-8 Insulation of Attic Supply Duct



DUCT SEALING

Code Section

402.4.1.1, 403.3.2, 403.3.6

Description

- The joints and seams of all ducts, air handlers, and filter boxes must be sealed with mastic or mastic tape that is at least 2mm in thickness (0.08 inch), approximately the thickness of a nickel.
- All duct connections must be mechanically fastened.
- Mastic shall be installed at the inner liner of rigid metal and flexible duct (not the outer insulation jacket). Mastic on ductboard should be on the outer foil face.
- HVAC register boots that penetrate the thermal envelope must be sealed to the subfloor or drywall.

Note, exceptions to duct sealing with mastic include the following:

- Ducts sealed with spray polyurethane foam
- Ducts with a static pressure classification of <math><2''</math> w.c. (500 Pa) that have continuously welded joints and seams, or locking-type joints and seams that are not snap-lock or button-lock. See 2015-IECC, R403.3.2.
- Inaccessible ductwork

Duct Sealing: Best Practices



CORRECT: Mastic-sealed Joints



INCORRECT: UL-181 Tape without Mastic



INCORRECT: No Mastic

Duct Sealing: Best Practices

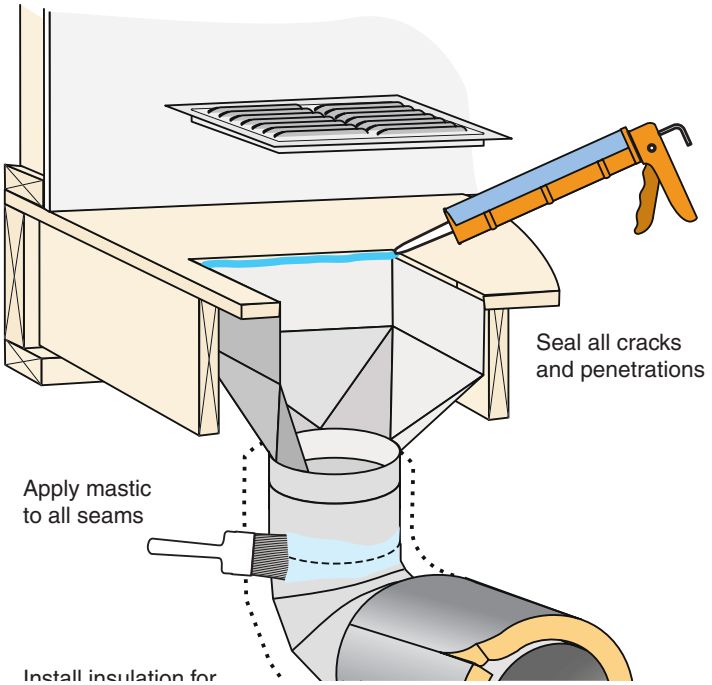
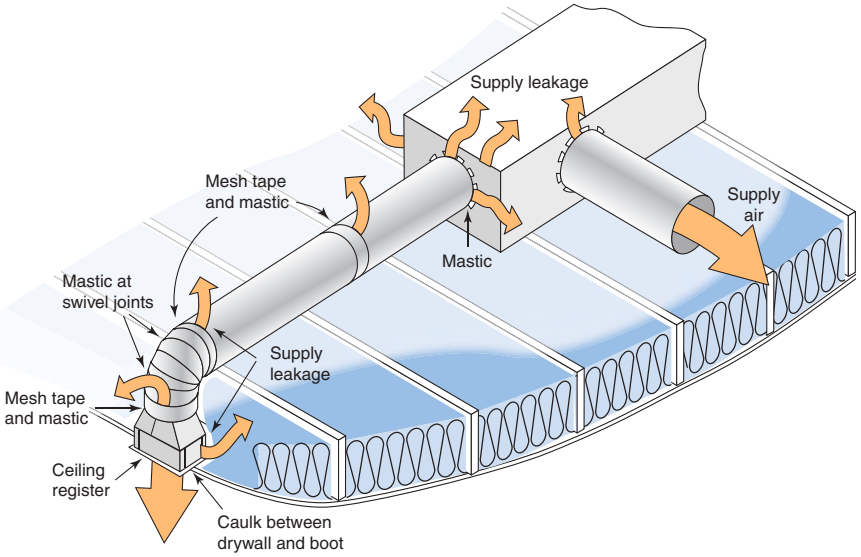

BUILDING CAVITIES MAY NOT BE USED AS DUCTS OR PLENUMS

Code Section

403.3.5

Description

- Unlined framing cavities may not be used as ducts or plenums.
- All supply and return ducts must be lined with metal, flex duct, ductboard, or other material approved in IRC Section M1601.

Correct/Incorrect Use of Building Cavity

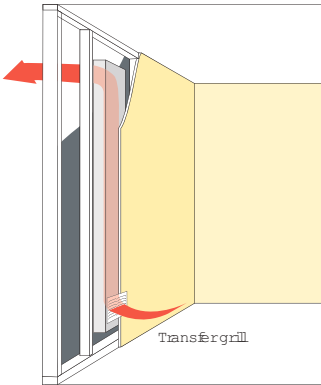

CORRECT: Metal-lined cavity



INCORRECT: Unlined cavity as plenum

HEATING, COOLING, AND WATER-HEATING EQUIPMENT

Code Section 401.3, 403.7

Description

- Heating and cooling equipment shall be sized in accordance with ACCA Manual S based on building loads calculated in accordance with ACCA Manual J or other approved heating and cooling calculation methodologies.
- New or replacement heating and cooling equipment shall have an efficiency rating equal to or greater than the minimum required by federal law for the geographic location where the equipment is installed.
- For automatically modulating capacity heating and cooling equipment, the system shall be deemed to comply with appropriate portions of Manual S, provided the lowest output capacity of the equipment is less than the peak design load as determined by Manual J. This means oversizing of equipment is permitted for variable speed (capacity) equipment, provided it can automatically throttle to a lower output than the calculated design load.
- Information about the type and efficiencies of the heating, cooling, and water heating equipment must be located on the energy code compliance certificate located either on or near the electrical distribution panel or main air handler.

Certificate Sample

Mechanical Summary					
HVAC Company Name			Contact (email/phone)		Date
Heating System Type	Efficiency (AFUE, HSPF, COP or other)	Cooling System Type	Efficiency (SEER, EER or other)	Water Heating Type	Efficiency (EF or other)
<input type="checkbox"/> Gas		<input type="checkbox"/> Air conditioner		<input type="checkbox"/> Gas	
<input type="checkbox"/> Heat pump		<input type="checkbox"/> Heat pump		<input type="checkbox"/> Electric	
<input type="checkbox"/> Other		<input type="checkbox"/> Other:		<input type="checkbox"/> Other:	
<input type="checkbox"/> Yes <input type="checkbox"/> No Manual J, S, D or equivalent complete?					
Required Mechanical Ventilation					
Type (check one)		Design Rate (check one)			
<input type="checkbox"/> Exhaust		<input type="checkbox"/> Continuous			
<input type="checkbox"/> Supply		<input type="checkbox"/> Intermittent			
<input type="checkbox"/> Balanced		If intermittent, list runtime in min. per hour		Design Ventilation Rate (CFM)	



Compliance certificate affixed to electrical panel or main air handler

PRIMARY HEAT SOURCE

Code Section 403.1.2, 403.1.2.3

Description

For new dwelling unit central HVAC systems (or replacement HVAC systems installed in dwelling units that were originally permitted after January 1, 1996), electric-resistance heat is not allowed as the primary heat source. Primary heat source is defined as the heat source for the original dwelling unit system.

PROGRAMMABLE THERMOSTAT

Code Section 403.1.1

Description

- At least one thermostat shall be provided for each separate heating and cooling system.
- The thermostat controlling the primary heating or cooling system of the dwelling unit shall be capable of controlling the heating and cooling system on a daily schedule to maintain different temperature set points at different times of the day.
- This thermostat shall include the capability to set back or temporarily operate the system to maintain zone temperatures down to 55°F (13°C) or up to 85°F (29°C).
- The thermostat shall initially be programmed by the manufacturer with a heating temperature set point no higher than 70°F (21°C) and a cooling temperature set point no lower than 78°F (26°C).

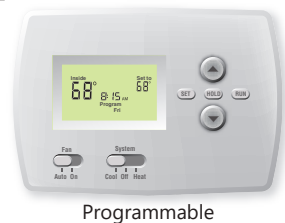

HEAT PUMP CONTROLS

Code Section

403.1.2

Description

- Heat pumps must have controls that will prevent supplemental electric-resistance heat from operating when the heating load can be satisfied by the heat pump compressor.
- Except in emergency heating mode, the supplementary electric-resistance heat in heat pump systems installed in *new construction* may not energize unless the outdoor temperature is below 40°F (4°C). This can most easily be accomplished via an outdoor unit lockout thermostat or other special HP programmable controls.



Example of a control

ROOMS CONTAINING COMBUSTION APPLIANCES

Code Section

402.4.4

Description

- In CZs 3-4 where combustion air ducts provide combustion air to open combustion fuel-burning appliances, the appliances and combustion air opening must be located outside the building thermal envelope or enclosed in a room and isolated from inside the thermal envelope.
- Such rooms must be sealed and insulated in accordance with the envelope requirements of Table R402.1.2, where the walls, floors and ceilings are no less than the basement wall R-value requirement.
- The door into the room must be fully gasketed, and any water lines and ducts in the room must be insulated in accordance with Section R403. The combustion air duct must be insulated to a minimum of R-8 where it passes through conditioned space.

Exceptions:

1. Direct vent appliances with both intake and exhaust pipes installed continuous to the outside
2. Fireplaces and stoves complying with Section R402.4.2 and Section R1006 of the IRC

Southface Recommended Practices:

- In tight homes, combustion air for fuel-burning appliances should not come from within the home (i.e., the occupant's air).
- Fuel-burning equipment should be located outside the building thermal envelope (such as a water heater in a garage) or either be direct vent (with intake and exhaust to the outdoors) or the equipment should be installed in a sealed "combustion closet" with combustion air provided from outdoors via "High/Low" vents as per the IRC.

Combustion closet

Combustion air inlets
as per mechanical and/or fuel gas code

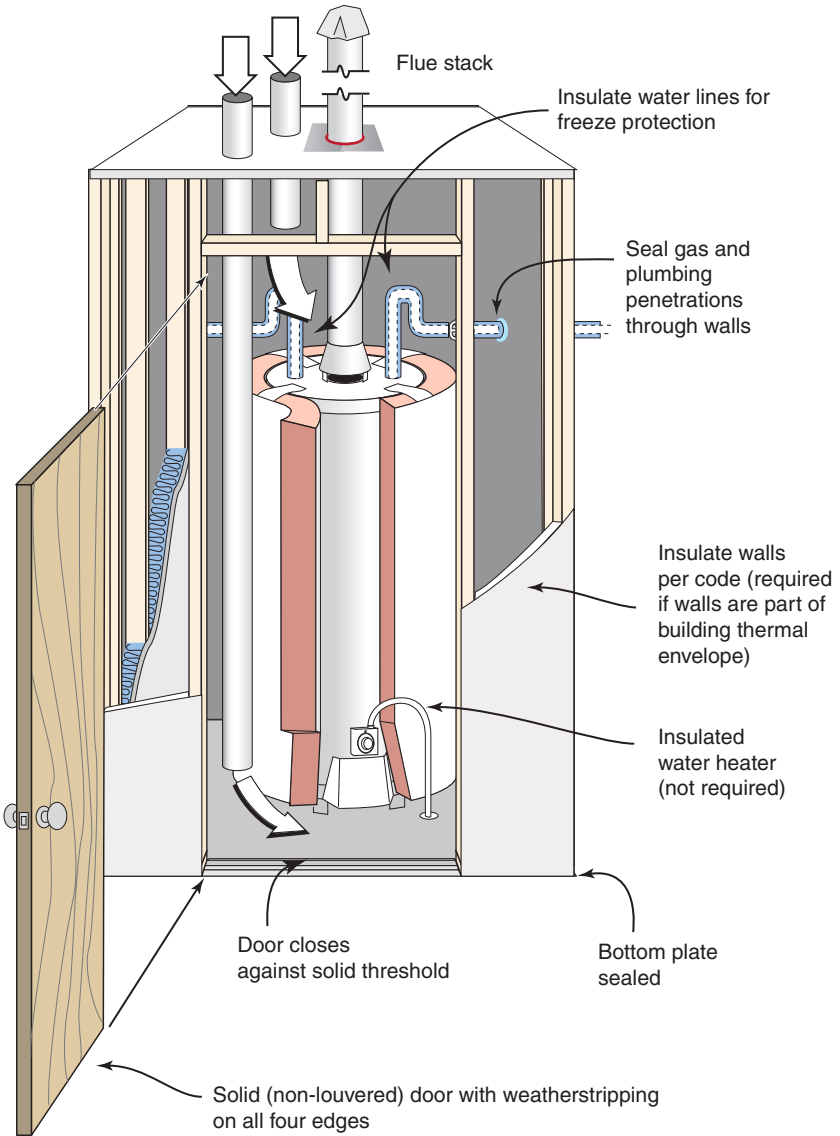

MECHANICAL VENTILATION

Code Section

403.6, 403.6.1, IRC M1507.3

Description

- As per the amended IRC 2018, whole-house mechanical ventilation is required for all homes in Georgia scoring < 3 ACH₅₀ on the blower door test. The 2020 Georgia amendments to the 2015 IECC require a blower door of < 5 ACH₅₀ for all climate zones.
- Where required, the building must have ventilation that meets IRC or IMC, as applicable, ASHRAE 62.2-2016 standard, or any other approved standard. Ventilation may be provided in a manner that creates a positive, negative, or balanced pressure on the home. The amount of ventilation required is based on the IRC table M1507.3.3:

Table M1507.3.3(1) Continuous Whole-House Mechanical Ventilation System Airflow Rate Requirements

DWELLING UNIT FLOOR AREA (square feet)	NUMBER OF BEDROOMS				
	0-1	2-3	4-5	6-7	>7
	Airflow in CFM				
< 1,500	30	45	60	75	90
1,501 - 3,000	45	60	75	90	105
3,001 - 4,500	60	75	90	105	120
4,501 - 6,000	75	90	105	120	135
6,001 - 7,500	90	105	120	135	150
> 7,500	105	120	135	150	165

For SI: 1 square foot = 0.0929 m², 1 cubic foot per minute = 0.0004719 m³/s.

- Intermittent ventilation may be utilized if the ventilation rate is increased in proportion to the fraction of runtime in a 4-hour segment (e.g., twice the ventilation rate for half the time, triple the ventilation for a third of the time, etc.).

Table M1507.3.3(2) Intermittent Whole House Mechanical Ventilation Rate Factors

RUN-TIME PERCENTAGE IN EACH 4-HOUR SEGMENT	25%	33%	50%	66%	75%	100%
Factor ^a	4	3	2	1.5	1.3	1.0

Mechanical Ventilation, continued

- All outdoor intake and exhaust openings must have either gravity (self-closing) or automatic dampers that will close when the system associated with the air intake or exhaust is not functioning.
- Mechanical ventilation system fans shall meet the following efficacy requirements:

Fan Location	Air Flow Rate Minimum (CFM)	Min. Efficacy (CFM/Watt)	Air Flow Rate Min (CFM)
Range Hoods	Any	2.8 cfm/watt	Any
In-Line Fan	Any	2.8 cfm/watt	Any
Bathroom/utility room	10	1.4 cfm/watt	<90
Bathroom/utility room	90	2.8 cfm/watt	Any

- Where mechanical ventilation fans are integral to tested and listed HVAC equipment, they must be powered by an electronically commutated motor.

Note: To ensure that dampers close correctly, direction of airflow must be taken into account when installed.

Southface Recommended Practices:

- While the IRC was amended in Georgia, it is strongly recommended that all homes have an intentional ventilation system installed to reduce liability and the risk of poor indoor air quality (IAQ). Due to humidity concerns, exhaust-only whole-house ventilation strategies are discouraged; however, intermittent spot exhaust fans of 50 CFM in bathrooms and 100 CFM in kitchens are still required.

POWER ATTIC VENTILATORS

Code Section

403.13

Description

- Power attic ventilators connected to the electric grid are not allowed. Power attic ventilators powered by a solar panel are permitted (but not recommended due to attic depressurization potentially pulling conditioned air from the house).



ALLOWED: Solar-powered ventilator



NOT ALLOWED: Grid-tied ventilator

OUTDOOR INTAKE/EXHAUST OPENINGS

Code Section

403.6

Description

- All outdoor intake and exhaust openings must have either gravity (self-closing) or automatic dampers that will close when the system associated with the air intake or exhaust is not functioning.
- To ensure that dampers close correctly, direction of airflow must be taken into account when installed

Intake/Exhaust Openings

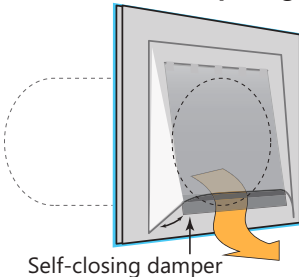

Motorized damper with ventilation controller

DUCT TIGHTNESS TESTING

Code Section 403.3.3, 403.3.4

Code Value Rough-In Total Leakage (RIT): $\leq 6\%$;
Post-Construction Total Leakage (PCT): $< 6\%$

Description

- The ducts and air handler must be tested for tightness if they are not located completely inside the conditioned spaces.
- Testing for duct tightness must be conducted by a certified Duct and Envelope Tightness (DET) verifier. The following tests are allowed: Rough-In Total Leakage (RIT) and Post-Construction (final) Total Leakage (PCT).
- The Post-Construction Leakage to Outside (PCO) test is no longer an option for energy code compliance.
- Duct testing results and other information about the test must be posted on the Energy Code Compliance Certificate.
- "6%" duct leakage means that a maximum of 6 CFM₂₅ of measured duct leakage (at 25 Pascals) per 100 sq. ft. of conditioned floor area served by that system is acceptable.
- Duct tightness testing is not required if less than 50% of an existing duct system is modified.
- If the air handler, furnace, or evaporator is replaced, testing is not required, but all joints, seams, and connections to plenums within 5 feet of new work must be sealed with mastic and verified by visual inspection by the state licensed conditioned air contractor or a DET verifier.

Duct Testing Certificate Example

Duct and Envelope Tightness Testing Summary			
DET Verifier	Contact (email/phone)		DET Verifier ID
Envelope Tightness Testing (< 5 ACH50) (Envelope Tightness = Blower Door Fan Flow x 60 / Thermal Envelope Volume)			
Blower Door Fan Flow (CFM50)	Thermal Envelope Volume (ft ³)	Envelope Tightness (ACH50)	
If multifamily unit and conducting sampling, this unit is not required to be tested. Mark N/A.			
Duct Tightness Testing (< 6 CFM25/100 ft²) (Total Duct Leakage = 100 x Fan Flow / Area Served)			
Number of Heating and Cooling Systems			
Duct Tightness Leakage Test Results			
	System 1	System 2	System 3
If air handler and ductwork located entirely within in condi-			
Location			
Fan Flow (CFM25)			
Area Served (ft ²)			
Total Duct Leakage (CFM25/100 ft ²)			
Rough In Total (RIT) or Post Construction Total (PCT)			

BLOWER DOOR TESTING

Code Section 402.4.1.2 + GA Amendments 402.4.1.3, 402.4.1.3.1

Code Value Single family: $< 5 \text{ ACH}_{50}$ where $\text{ACH}_{50} = \text{CFM}_{50} \times 60 / \text{Volume}$
 Low-rise R-2 multifamily:
 $< 7 \text{ ACH}_{50}$; or $< 0.35 \text{ ELR}_{50}$
 where $\text{ELR}_{50} = \text{CFM}_{50} / \text{Envelope Shell Area (sq. ft.)}$

Description

- All new construction and full (gut) renovations that affect all aspects of the building thermal envelope must be tested for tightness with a blower door. Testing shall be performed at any time after creation of all penetrations of the building thermal envelope have been sealed (usually at final).
- Testing for building envelope tightness must be conducted by a certified Duct and Envelope Tightness (DET) verifier.
- Details of the test results and test specifications should be made available on the Energy Code Compliance Certificate.
- Low-rise R-2 multifamily dwellings must be tested to less than 7 air changes per hour at 50 Pascals (ACH_{50}).
- As an alternative to ACH_{50} , compliance for low-rise R-2 dwellings may be attained by achieving an Envelope Leakage Ratio at 50 Pascals (ELR_{50}) of less than 0.35 ($\text{ELR}_{50} < 0.35$ where $\text{ELR}_{50} = \text{CFM}_{50} / \text{Envelope Shell Area, sq. ft.}$).

Low-rise R-2 MF testing may use one or both of the following protocols:

1. Utilize multiple fans in adjacent units (commonly referred to as Guarded Blower Door testing) to minimize effect of leakage to adjacent units (not required).
2. Envelope testing of less than 100 percent is acceptable assuming a maximum sampling protocol of 1 in 4 units per floor. If sampled unit passes, the remaining units (up to three) are deemed to comply; if sampled unit fails, it must be sealed and retested, and the remaining units must also be tested.

Duct and Envelope Tightness Testing Summary		
DET Verifier	Contact (email/phone)	DET Verifier ID
Envelope Tightness Testing ($< 5 \text{ ACH}_{50}$) (Envelope Tightness = Blower Door Fan Flow x 60 / Thermal Envelope Volume)		
Blower Door Fan Flow (CFM_{50})	Thermal Envelope Volume (ft^3)	Envelope Tightness (ACH_{50})
If multifamily unit and conducting sampling, this unit is not required to be tested. Mark N/A.		

DET blower door testing summary

Blower Door Setup

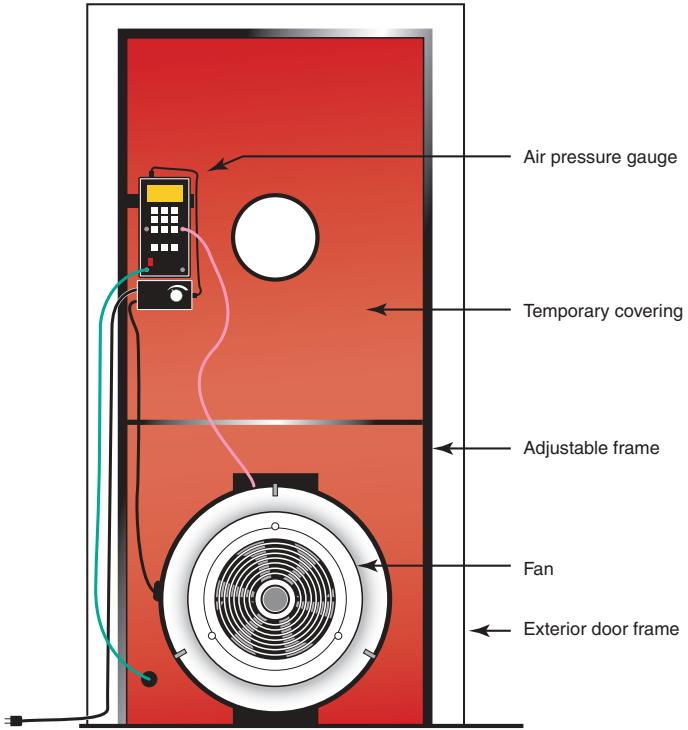

Typical blower-door setup

ENERGY CODE COMPLIANCE CERTIFICATE

Code Section

401.3

Description

- A permanent certificate must be completed by the builder or registered design professional and posted on or near the electrical distribution panel or the main air handling unit (such as a wall in the space where the air handler is located, in a utility room, or in another approved location in the building). If located on an electrical panel, the certificate must not obstruct the visibility of the circuit directory or other required labels.
- Details for HVAC Manual J, S, and D calculations and mechanical ventilation (if required) must be completed and confirmed on the energy code compliance certificate.
- Where required by the code official, testing will be conducted by an approved third party. A written report of the test results must be signed by the party conducting the test and provided to the code official.

Compliance Certificate

APPENDIX RD
MANDATORY COMPLIANCE CERTIFICATE

2020 Georgia Residential Energy Code Compliance Certificate					Jurisdiction Logo and/or Contact Information Here	
This certificate shall be posted on or near the electrical distribution panel or air handler						
Permit # _____						
House Address or Community/Lot# _____						
Building Summary						
Builder/Company Name		Signature		Contact (email/phone)		Date
Compliance Pathway (check one)			Building Envelope (when multiple values per component, list value covering largest area)			
<input type="checkbox"/> Prescriptive: R401-404			Ceiling/Roof R-value		Above-grade mass wall R-value	
<input type="checkbox"/> UA Trade-off: R402.1.5			Sloped/vaulted ceiling R-value		Cantilevered floors R-value	
<input type="checkbox"/> RESCheck: Keyed to 2015 IECC			Exterior wall R-value		Window/Glass Door SHGC	
<input type="checkbox"/> Simulated Performance: R405			Kneewall (cavity and/or continuous) R-value		Window/Glass Door U-factor	
<input type="checkbox"/> Energy Rating Index (ERI): R406			Foundation (cavity and/or continuous) R-value		Skylight SHGC	
ERI Score _____			Floors over unconditioned R-value		Skylight U-factor	
Mechanical Summary						
HVAC Company Name			Contact (email/phone)			Date
Heating System Type		Efficiency (AFUE, HSPF, COP or other)	Cooling System Type		Efficiency (SEER, EER or other)	Water Heating Type
<input type="checkbox"/> Gas			<input type="checkbox"/> Air conditioner			<input type="checkbox"/> Gas
<input type="checkbox"/> Heat pump			<input type="checkbox"/> Heat pump			<input type="checkbox"/> Electric
<input type="checkbox"/> Other			<input type="checkbox"/> Other:			<input type="checkbox"/> Other:
<input type="checkbox"/> Yes <input type="checkbox"/> No		Manual J, S, D or equivalent complete?				
Required Mechanical Ventilation						
Type (check one)			Design Rate (check one)			
<input type="checkbox"/> Exhaust			<input type="checkbox"/> Continuous		Design Ventilation Rate (CFM)	
<input type="checkbox"/> Supply			<input type="checkbox"/> Intermittent			
<input type="checkbox"/> Balanced			If intermittent, list runtime in min. per hour			
Duct and Envelope Tightness Testing Summary						
DET Verifier		Contact (email/phone)			DET Verifier ID	
Envelope Tightness Testing (< 5 ACH50)			(Envelope Tightness = Blower Door Fan Flow x 60 / Thermal Envelope Volume)			
Blower Door Fan Flow (CFM50)			Thermal Envelope Volume (ft ³)		Envelope Tightness (ACH50)	
If multifamily unit and conducting sampling, this unit is not required to be tested. Mark N/A.						
Duct Tightness Testing (< 6 CFM25/100 ft²)			(Total Duct Leakage = 100 x Fan Flow / Area Served)			
Number of Heating and Cooling Systems _____						
Duct Tightness Leakage Test Results			System 1		System 2	System 3
If air handler and ductwork located entirely within in condi-						
Location						
Fan Flow (CFM25)						
Area Served (ft ²)						
Total Duct Leakage (CFM25/100 ft ²)						
Rough In Total (RIT) or Post Construction Total (PCT)						

Version 1.0

LIGHTING

Code Section

404.1, 404.1.1

Description

- To be deemed compliant under the prescriptive or trade-off approach, at least 75 percent of lamps in permanently installed fixtures must be high-efficacy. Exception: low-voltage lighting.
- Definition of *high-efficacy lamps*: Compact fluorescent lamps, T-8 or smaller diameter linear fluorescent lamps, or lamps such as LED with a minimum efficacy of:
 - 1) 60 lumens per watt for lamps over 40 watts;
 - 2) 50 lumens per watt for lamps between 15 and 40 watts; and
 - 3) 40 lumens per watt for lamps of 15 watts or less.

Bulb Examples

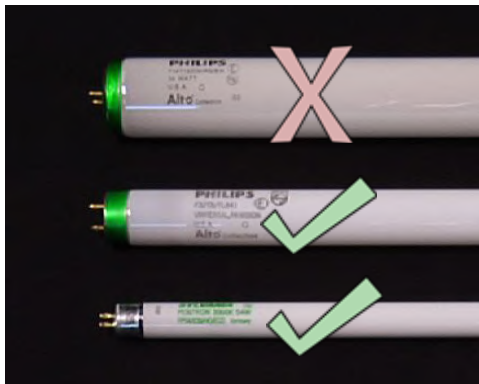

WOOD-BURNING FIREPLACES

Code Section

402.4.2

Description

- New wood-burning fireplaces must have tight-fitting flue dampers or doors and outdoor combustion air. This combustion air should have a damper as per 402.4.1.2 which (along with the flue) should be closed during a blower door test.
- Where tight-fitting doors are used on factory built fireplaces listed and labeled in accordance with UL 127, the doors shall be tested and listed for the fireplace.
- Where tight-fitting doors are used on masonry fireplaces, the doors shall be listed and labeled in accordance with UL 907.



Wood-burning fireplace features dampered outdoor combustion air and tight-fitting flue damper.

HEATED SWIMMING POOLS AND SPAS

Code Section

403.10

Description

- Spas and swimming pools must comply with APSP-145, APSP-14, and APSP-15, as applicable.
- For pools with heaters, the electric power to heaters must be controlled by a readily accessible On/Off switch that is an integral part of the heater, mounted on the exterior of the heater, or external to and within 3 feet (914 mm) of the heater. Operation of such a switch must not change the setting of the heater thermostat. Such switches must be in addition to a circuit breaker for the power to the heater.
- Gas-fired heaters must not be equipped with continuously burning ignition pilots.
- Time switches or other control methods that can automatically turn off and on according to a preset schedule must be installed for heaters and pump motors. Heaters and pump motors that have built-in time switches must be in compliance with this section.

Exceptions:

1. Where public health standards require 24-hour pump operation
 2. Pumps that operate solar and waste-heat-recovery heating systems
- A vapor-retardant cover or other approved vapor-retardant means must be installed to cover outdoor heated pools and outdoor permanent spas. Exception: Where more than 70 percent of the energy for heating (as computed over an operation season) is from site-recovered energy, such as from a heat pump or solar energy source, covers or other vapor-retardant means are not required.



Relax!